

CERAMIC

SIT-IN / SEMI RECESSED / INSET

essenza & onesto

The Essenza and Onesto offer modern solutions and timeless beauty – the perfect complement to a contemporary or traditional setting. The Essenza (sit-in, semi-recessed) provides a spacious main bowl with useful half bowl, whilst the Onesto (inset) provides a half bowl with large, useful run-off drainer.

Features – Essenza

- » Manufactured from luxury ceramic fireclay
- » Spacious main bowl suitable for washing large non-dishwasher items
- » The half bowl is situated at the back of the sink to exploit maximum area for the main bowl.

Features – Onesto

- » 1.5 Bowl inset sink with a unique overflow, and run off drainer
- » Manufactured from luxury ceramic fireclay
- » Left or right handed drainer
- » Expansive main bowl makes it suitable for washing large items.
- » Minimum base unit: 600mm

ESSENZA 1.5 BOWL

colour/finish available



Matt White



THE MODERN ESSENZA AND ONESTO ARE MADE FROM HIGH QUALITY CERAMIC FIRECLAY GIVING A STUNNING SMOOTH, MATT FINISH



Essenza 1.5 Bowl with Statura Tap

available in Ceramic Fireclay



ONESTO

Onesto 1.5 Bowl (RHD) with Quadratto Tap



Left or right handed drainer

ONESTO 1.5 BOWL



AVAILABLE IN LUXURY CERAMIC FIRECLAY BOTH THE ESSENZA AND ONESTO ADD STYLE TO ANY CONTEMPORARY OR TRADITIONAL KITCHEN

geo

With the phenomenal success of the composite Geo, the matt ceramic version offers the same innovative design and stunning good looks. Featuring the same geometric lines and unique square waste this proves a very practical and modern addition to the Studio collection.

Features

- » Clean, geometric lines and smooth contours
- » Unique square wastes complement the overall contemporary look
- » Matt white ceramic finish presents a defining statement in design and function
- » Minimum base unit: 600mm

THE CERAMIC VERSION OF THE POPULAR COMPOSITE SINK IS MADE FROM HIGH QUALITY CERAMIC FIRECLAY GIVING A STUNNING SMOOTH, MATT FINISH



Geo 1.0 Bowl with Vanquish Tap

available in Ceramic Fireclay



Reversible

GEO 1.0 BOWL

OPTIONAL Accessories

colour/finish available



Matt White



IROKO
CHOPPING BOARD

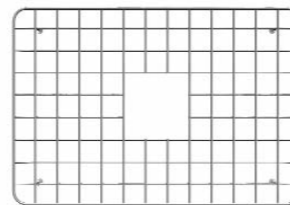

GRID 1.0 BOWL

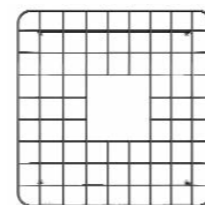

GRID 1.5 BOWL



Geo 1.5 Bowl and Iroko Chopping Board with Vanquish Tap



Reversible

GEO 1.5 BOWL



WITH THE PHENOMENAL SUCCESS OF THE COMPOSITE VERSION, THE CERAMIC GEO OFFERS THE SAME INNOVATIVE DESIGN AND STUNNING GOOD LOOKS

jersey & equinox

The Jersey ceramic sink features spacious bowls combined with an elegant wide expanse drainer area. This stunning oversized fireclay sink is a statement of function and design emanating quality and style.

The Equinox ceramic sinks are hand finished to give excellent quality, depth and texture. Available in both 1.0 and 1.5 bowl variants the Equinox is undoubtedly the most contemporary functional inset ceramic available.

Features – Jersey

- » Traditionally styled
- » Available in 1.5 bowl only
- » Hand finished in high gloss ceramic
- » Pop-up waste as standard.

Features – Equinox

- » Flexible sink at home in either a modern or traditional kitchen setting
- » Hand finished in high gloss ceramic
- » Generous bowl make this a practical sink
- » Sleek contours and a linear drainer add to the overall clean look of the sink.

JERSEY 1.5 BOWL

colour/finish available



Gloss White



THE SPACIOUS JERSEY AND FUNCTIONAL EQUINOX ARE MADE FROM CERAMIC FIRECLAY GIVING A STUNNING SMOOTH, HIGH GLOSS FINISH



Jersey 1.5 Bowl (RHD) with Jordan Springflow® Tap

available in Ceramic Fireclay



Left of Right Handed Drainer



Equinox 1.5 Bowl with Ocean Tap



EQUINOX 1.0 BOWL

Reversible



EQUINOX 1.5 BOWL

Reversible



AVAILABLE IN BOTH 1.0 AND 1.5 BOWL VARIANTS THE EQUINOX IS UNDOUBTEDLY THE MOST CONTEMPORARY FUNCTIONAL INSET CERAMIC AVAILABLE

CERAMIC
SIT-IN / INSET

edinburgh & aquitaine

The bow fronted Edinburgh sink offers an elegant spacious fireclay sink that gives a fresh alternative to timeless classic Belfast.

The Aquitaine combines curvaceous contours with a solid ceramic finish. Available in 1.0 and 1.5 bowl variants.

Features – Edinburgh

- » Spacious sink with generous bowl size
- » At home in either a modern or traditional setting
- » Finished in a stunning high gloss finish

Features – Aquitaine

- » Both the 1.0 and 1.5 bowl are reversible
- » Solid, curvaceous contours and a defined linear drainer pattern combine to create a sink equally at home in traditional and modern kitchens alike
- » Generous bowl and drainer sizes make this sink a practical solution
- » Finished in a stunning high gloss finish
- » Optional accessories available.

EDINBURGH 1.0 BOWL

colour/finish available



Gloss White



THE BOW FRONTED EDINBURGH AND THE CURVACEOUS AQUITAINE ARE MADE FROM HIGH GLOSS CERAMIC FIRECLAY GIVING A STUNNING SMOOTH, CONTEMPORARY FINISH



Edinburgh sink

available in Ceramic Fireclay



Aquitaine 1.5 Bowl with Colonial Tap



AQUITAINE 1.0 BOWL

Reversible



AQUITAINE 1.5 BOWL

Reversible



AQUITAINE, DISTINCTIVELY DESIGNED TO OFFER A FRESH, DEFINED STYLING TO A CERAMIC SINK

CERAMIC
SIT-IN

belfast & butler drainer

The Belfast sink has become a popular household addition in recent years. Our luxury straight-sided thick walled version is an exact replica of the original Victorian design. The sink has a deep bowl, ideal for larger items, and comes complete with chrome waste and traditional integrated weir overflow.

The Butler Drainer is a superb additional item to the Belfast sink – sitting on top of your worktop it allows you to use it for draining or as an additional preparation area.

Features

- » The weir overflow adds to the classic look of the sink
- » At home in a traditional kitchen
- » Individually hand crafted
- » Fits on a standard Belfast sink base cabinet
- » Finished in ceramic fireclay
- » The Butler Drainer is a practical addition to any Butler sink in the range.

THE BUTLER SINKS RANGE FROM ASTRACAST ARE TIMELESS CLASSICS, ELEGANT AND SPACIOUS TO SUIT ANY STYLE KITCHEN



Belfast sink and Butler drainer with Ocean Tap

available in Ceramic Fireclay



BELFAST

colour/finish available



Gloss White



BUTLER DRAINER

Belfast sink and Butler drainer with Ocean Tap



BUTLER DRAINER



THE BELFAST SINK HAS BECOME A POPULAR HOUSEHOLD ADDITION IN RECENT YEARS. OUR LUXURY STRAIGHT-SIDED THICK WALLED VERSION IS AN EXACT REPLICA OF THE ORIGINAL VICTORIAN DESIGN

PLEASE NOTE: ALL CERAMIC SINKS DUE TO MATERIAL PROPERTIES AND THE HANDMADE MANUFACTURING PROCESS OF THE CERAMIC SINKS, WE STRONGLY RECOMMEND ANY CUT OUTS MADE TO WORKTOPS ARE MADE BASED ON YOUR INDIVIDUAL SINK DIMENSIONS.

CERAMIC
SIT-IN

canterbury & sudbury

Manufactured from Premium Fireclay High Gloss Ceramic the Canterbury is a modern alternative to the traditional styled Belfast sink.

The Sudbury has very clean, angular contours giving a contemporary look which is equally at home in both modern and traditional environments. Available in both single and a large double bowl version for ultimate flexibility.

Both models are capable of handling larger items such as grill pans and woks.

Features – Canterbury

- » Modern design based on the traditional Butler style sink
- » Straight lines give the sink a distinctly contemporary feel
- » Can be installed with all worktop types (including laminate)
- » Practical half bowl at the rear of the sink.

Features – Sudbury

- » Design at home in either a traditional or contemporary setting
- » Large bowl sizes on both sinks make this a practical option
- » Clean angular contours.

CANTERBURY 1.5 BOWL

colour/finish available



Gloss White



THE CANTERBURY AND SUDBURY SINKS ARE CLASSIC, TRADITIONAL STYLED SINKS WHICH ARE THE PINNACLE OF FORM AND FUNCTION AND A TALKING POINT OF ANY KITCHEN



Canterbury 1.5 Bowl with Planar Tap

available in Ceramic Fireclay



Sudbury 2.0 Bowl with Camargue Bridge Tap



SUDBURY 1.0 BOWL



SUDBURY 2.0 BOWL



THE SUDBURY HAS VERY CLEAN, ANGULAR CONTOURS GIVING A CONTEMPORARY LOOK EQUALLY AT HOME IN BOTH MODERN AND TRADITIONAL ENVIRONMENTS

PLEASE NOTE: ALL CERAMIC SINKS DUE TO MATERIAL PROPERTIES AND THE HANDMADE MANUFACTURING PROCESS OF THE CERAMIC SINKS, WE STRONGLY RECOMMEND ANY CUT OUTS MADE TO WORKTOPS ARE MADE BASED ON YOUR INDIVIDUAL SINK DIMENSIONS.

STAINLESS STEEL
UNDERMOUNT

edge

The Edge range features contemporary minimalist styling with highly functional main bowls. All main bowls feature a bowl grid to protect and prolong the Premium Polished Steel Finish.

Features

- » Stunning mounted in granite and solid surface worktops (not suitable in laminated worktops)
- » Ideal for teaming with large feature taps
- » Contemporary styling with easy to clean tight radiused corners
- » Ideal for island unit application
- » Ideal for use with waste disposal units
- » Deep large main bowl (200mm)
- » Main bowl grids included

ONLY SUITABLE FOR GRANITE OR SOLID SURFACE WORKTOPS.

EDGE/H1/S1/S2/D1 BOWLS

Accessories

sink finish available



Polished



GRIDS to fit size of sink
(Excluding H1)



GRID FOR S2
(Included)



GRID FOR S1/D1
(Included)



Echo 1.0 S1 Bowl with Nordic Professional Tap

available in polished steel



EDGE 0.5 H1 BOWL



EDGE 1.0 S1 BOWL



EDGE 1.0 S2 BOWL



EDGE 1.5 D1 BOWL

THE EDGE RANGE OF UNDERMOUNT SINKS COMBINES STUNNING LOOKS WITH ULTRA MODERN STYLING IN A PREMIUM POLISHED FINISH



Edge 1.5 D1 Bowl with Grid and Leda Tap



ALL MAIN BOWLS FEATURE BOWL GRIDS AS STANDARD TO PROTECT AND PROLONG THE SINKS PREMIUM POLISHED FINISH

STAINLESS STEEL
UNDERMOUNT

echo

The Echo range features modern, minimalist design with highly functional main bowls. Both the S1 and S2 single bowls feature the deepest bowls available for a standard single bowl undermount within the UK – the S2 has a superior bowl width of 510mm.

Four of the five bowl variants (excluding the half bowl) feature main bowl grids as standard to protect the deep main bowls and prolong the sinks Premium Polished Steel finish.

Features

- » Stunning mounted in granite and solid surface worktops (not suitable in laminated worktops)
- » Ideal for teaming with large feature taps
- » Compact, easy clean with radiused corners
- » Ideal for island unit application
- » Ideal for use with waste disposal units
- » All main bowls are deeper than most undermounted sinks on the market (195mm)
- » Grid included to protect bowl.

ONLY SUITABLE FOR GRANITE OR SOLID SURFACE WORKTOPS.

ECHO/H1/S1/S2 BOWLS

Accessories

sink finish available



Polished



MAHOGANY CHOPPING BOARD (Optional)

GRIDS to fit size of sink (Excluding H1)

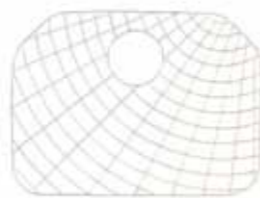

GRID FOR S2 (Included)

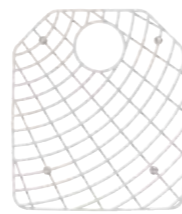

GRID FOR S1, D1 & D2 (Included)



Echo 1.0 S1 Bowl with Professional Tap

available in polished steel



ECHO 0.5 H1 BOWL



ECHO 1.0 S1 BOWL



ECHO 1.0 S2 BOWL

THE ECHO RANGE OF SINKS ARE STUNNING CONTOURED, UNDERMOUNT SINKS WITH EXTRA DEEP BOWLS, FINISHED IN POLISHED STEEL FOR CONTEMPORARY STYLING



Echo 1.5 D1 Bowl with Nordic Professional Tap



ECHO 1.5 D1 BOWL



ECHO 2.0 D2 BOWL



FOUR OF THE FIVE BOWL VARIANTS FEATURE MAIN BOWL GRIDS AS STANDARD TO PROTECT THE DEEP MAIN BOWLS AND PROLONG THE SINKS PREMIUM POLISHED STEEL FINISH

STAINLESS STEEL

UNDERMOUNT / INSET – FEATURE SINK

onyx

The Onyx Inset/Undermount sinks are manufactured from Premium Brushed Steel and the Inset version can be fitted into any worktop material including laminate – giving the look and feel of a designer sink without the added expense of polishing granite or rounding edges.

Features

- » Can be used with granite and solid surface worktops (undermounted) or with laminate worktops (inset)
- » Compact, easy clean with radiused corners
- » Ideal for compact kitchens where space is limited or for island unit application
- » Mix and match between the various bowl configurations to customise the work centre
- » Achieve a streamlined undermount look without the need for solid surface worktops (inset)
- » Drainer benefits from slimline waste, which allows fitting over appliances such as dishwashers.



*Onyx Drainer Comes with slim drainer waste to enable you to position the drainer in the worktop above appliances such as dishwashers.

ONYX 0.5/1.0M

Accessories

sink finish available



Brushed



DEMI DRAINER TO FIT HALF BOWL (Included)



GRID TO FIT SIZE OF SINK (Included)



MAHOGANY CHOPPING BOARD (Optional)



Onyx 1.0 Medium Bowl, Half Bowl (Inset), Grids and Chopping Board with Victory Tap

available in brushed steel



ONYX HALF BOWL 4016



ONYX MEDIUM BOWL 4034



ONYX DRAINER 4034



ONYX LARGE BOWL 4054

The Onyx Large Bowl is not available as a Feature Sink Pack.

THE ONYX RANGE OF INSET/ UNDERMOUNT SINKS OFFER MODERN, MINIMALISTIC DESIGN AND VERSATILITY TO ALL KITCHEN ENVIRONMENTS



Onyx 1.0 Medium Bowl and Drainer (Undermounted) with Victory Tap

ONYX



THE ONYX INSET/UNDERMOUNT SINKS ARE MANUFACTURED FROM PREMIUM BRUSHED STEEL AND CAN BE FITTED INTO ANY WORKTOP MATERIAL INCLUDING LAMINATE – GIVING THE LOOK AND FEEL OF A DESIGNER SINK WITHOUT THE ADDED EXPENSE OF POLISHING GRANITE OR ROUNDING EDGES

FOR MORE OF THE ONYX RANGE SEE OVERLEAF.

STAINLESS STEEL
UNDERMOUNT / INSET

onyx

The Onyx Inset/Undermount sinks are manufactured from Premium Brushed Steel (round bowls polished finish only). The Inset versions can be fitted into any worktop material including laminate – giving the look and feel of a designer sink without the added expense of polishing granite or rounding edges.

Features

- » Can be used with granite and solid surface worktops (undermounted) or with laminate worktops (inset)
- » Compact, easy clean with radiused corners
- » Ideal for compact kitchens where space is limited or for island unit application
- » Mix and match between the various bowl configurations to customise the work centre
- » Achieve a streamlined undermount look without the need for solid surface worktops (inset)
- » Drainer benefits from slimline waste, which allows fitting over appliances such as dishwashers.



FEATURE SINK
(Onyx 1.5 Bowl / 2.0 Bowl)

ONYX 1.5 BOWL/2.0 BOWL

Accessories

sink finishes available



Accessories for 1.5 and 2.0 Bowl sinks only.



DEMI DRAINER TO FIT HALF BOWL (Included)



GRID TO FIT SIZE OF SINK (Included)



MAHOGANY CHOPPING BOARD (Optional)



Onyx 1.5 Bowl (Inset) and Grids with Victory Tap

available in brushed steel



ONYX 1.5 BOWL 4053 (RHD ONLY)



ONYX 2.0 BOWL 4070

THE ONYX RANGE OF INSET/ UNDERMOUNT SINKS OFFER MODERN, MINIMALISTIC DESIGN AND VERSATILITY TO ALL KITCHEN ENVIRONMENTS



Onyx 2.0 Bowl (Inset) with Victory Tap



available in polished steel

♦ ONYX ROUND BOWL



Round versions only available in polished steel

♦ ONYX ROUND DRAINER

♦ Please note: Inset installation only. Not suitable for undermounting.



Onyx 1.5 Bowl (Undermounted) with Orinoco Tap



THE ONYX INSET/UNDERMOUNT SINKS ARE MANUFACTURED FROM PREMIUM BRUSHED STEEL AND CAN BE FITTED INTO ANY WORKTOP MATERIAL INCLUDING LAMINATE – GIVING THE LOOK AND FEEL OF A DESIGNER SINK WITHOUT THE ADDED EXPENSE OF POLISHING GRANITE OR ROUNDING EDGES

opal

The opal range of classic, undermount sinks offer a wide choice in size and shape and are designed to complement granite and hardwood surfaces. The Opal Premium Stainless Steel sinks feature unique sound deadening spray – the innovative spray covers the entire back face of the sink totally eliminating sound resonance and insulating the bowl, preventing heat loss and maintaining water temperature for longer.

Features

- » Stunning mounted in granite and solid surface worktops (not suitable in laminated worktops)
- » Excellent sound deadening
- » Wide range of options
- » Ideal for island unit application
- » Ideal for use with waste disposal units.

THE OPAL RANGE OF CLASSIC UNDERMOUNT SINKS OFFER A WIDE CHOICE IN SIZE AND SHAPE AND ARE DESIGNED TO COMPLEMENT GRANITES AND HARDWOOD SURFACES



Opal 1.5 Bowl with Professional Tap

available in polished steel



OPAL H1 0.5 BOWL

OPAL S1 LARGE BOWL

OPAL S2 CLASSIC BOWL

OPAL BOWLS

sink finish available



Polished



OPAL R1 ROUND BOWL



OPAL R2 ROUND DRAINER

GRID/BASKETS
SELECTION OF CHOPPING BOARDS
(See technical specifications at back of brochure)



Opal S3 1.5 Bowl with Professional Tap



OPAL S3 1.5 BOWL

Left or Right Handed



OPAL 1.5 BOWL

Reversible



OPAL 0.5 BOWL



OPAL 1.0 BOWL

CERAMIC
UNDERMOUNT

lincoln

The Lincoln range of ceramic fireclay undermounts offers versatile styling within modern kitchen environments. The range features seven dimensional options including half, main, round bowls and round drainers – each manufactured from high quality fireclay with a traditional high gloss finish.

Suited to any solid surface material the Lincoln undermount range can be paired in various configurations to suit all kitchen sizes.

Features

- » Stunning contrast when under-mounted in black granite worktops
- » Superb white fireclay gloss finish
- » Ideal teamed with stainless steel taps
- » Easy to clean and maintain
- » Sinks sit in 1000mm base units (for combinations of half and main bowl sinks).

(SUITABLE FOR GRANITE AND SOLID SURFACES WORKTOPS ONLY).

LINCOLN/2035/2540/3040

colour/finish available



Gloss White

THE LINCOLN RANGE OF CERAMIC UNDERMOUNTS ARE HIGH QUALITY, MODERN AND VERSATILE



Lincoln 4040 and Lincoln 2035 with Vanguard Tap

available in white ceramic



LINCOLN 2035
HALF BOWL



LINCOLN 2540
HALF BOWL



LINCOLN 3040
MAIN BOWL



Lincoln Round Bowl and Drainer with Voyager Tap



LINCOLN 4040
MAIN BOWL



LINCOLN 5040
MAIN BOWL



LINCOLN ROUND BOWL



LINCOLN ROUND DRAINER



SUITED TO ANY SOLID SURFACE MATERIAL THE LINCOLN UNDERMOUNT RANGE CAN BE PAIRED IN VARIOUS CONFIGURATIONS TO SUIT ALL KITCHEN SIZES



CERAMIC
UNDERMOUNT

vero

The Vero range of ceramic fireclay undermounts offers a distinctive contemporary appearance. The range features four dimensional options including half, medium, large and 1.5 bowl – each manufactured from high quality fireclay with a white matt or black gloss finish.

Both versions look stunning against solid surfaces and dark granite worktops.

Features

- » Modern solutions and timeless beauty – the perfect complement to a contemporary kitchen setting
- » Striking when mounted into contrasting granite or solid surface
- » Minimalistic design with versatile bowl configurations
- » Minimum base unit:
 - Half bowl – 400mm
 - Medium bowl – 500mm
 - Large bowl – 600mm
 - 1.5 bowl – 800mm

(SUITABLE FOR GRANITE AND SOLID SURFACES WORKTOPS ONLY).

VERO HALF/MEDIUM

colours/finishes available



PLEASE NOTE: ALL CERAMIC SINKS DUE TO MATERIAL PROPERTIES AND THE HANDMADE MANUFACTURING PROCESS OF THE CERAMIC SINKS, WE STRONGLY RECOMMEND ANY CUT OUTS MADE TO WORKTOPS ARE MADE BASED ON YOUR INDIVIDUAL SINK DIMENSIONS.

THE VERO RANGE OF CERAMIC UNDERMOUNTS ARE HIGH QUALITY, MODERN AND VERSATILE AND FINISHED IN A DISTINCTIVE MATT FINISH



Vero 1.5 Bowl in Granite Black with Statura Tap

available in white and granite black ceramic



VERO

Vero Medium and Half bowl in white with Rispetto Tap



VERO LARGE



VERO 1.5 BOWL



IDEALLY SUITED TO ANY SOLID SURFACE MATERIAL THE VERO UNDERMOUNT RANGE OFFERS A STUNNING APPEARANCE TO SUIT ALL KITCHEN STYLES



Vanguard TP0728
- Polished



Photograph courtesy of Burbidge Crafted Design

Nordic Multi Professional Tap

Taps



FROM THE RUSTIC FARMHOUSE TO THE
ULTRA MODERN PENTHOUSE APARTMENT
THERE IS A TAP TO COMPLEMENT
AND FINISH THE SETTING.

WITH A MYRIAD OF COLOURS, FINISHES AND
ADDITIONAL FUNCTIONS, MAKE THIS
AN UNPARALLELED FAMILY FROM WHICH
TO SELECT YOUR PERFECT TAP

taps to complement your kitchen...

The perfect finishing touch with one of the most important accessories in any kitchen!

Astracast's stylish taps are in-line with most kitchen manufacturers gleaming finishes and will complement all kitchen styles – whether city slick, rural chic or country farmhouse, there will be a style of tap available to scintillate all tastes.

Our wide range of taps are available in either:-

- Stainless Steel
- Professional
- Contemporary
- Classic
- Traditional
- and not forgetting...
- Springflow® our fantastic water filtration system.



Colour Coding

Throughout this tap section each tap has its own individual colour-coded, key features. The colours aim to make it easier to pick out the features you want when making your choice of tap.

Tap features

- High Pressure
- Med Pressure
- Low Pressure
- Compression
- Single Flow
- Dual Flow
- Quarter Turn
- Pull-Out
- Directional Spray
- Swivel Body

Design and Innovation

From designer waterfall spouts to ceramic style traditional handles, every detail has been considered on each tap so that no matter what your kitchen style is, there is a tap to match. Our collection collates the taps by style and function which can help guide your choice. Use the colour-coded key features to help identify the features and benefits that would most complement your kitchen.

Understanding tap dimensions

The dimensions of the taps are located in the following technical specifications section, the measurements are in order of tap height, spout reach and spout height.



Water Pressure

When choosing a tap you need to consider the water pressure available in your home. (See operating pressures for each tap in the technical specifications at the back of the brochure). Cold water will be at mains pressure so is not usually a problem*, the pressure at which your hot water comes out the tap is vital and you must note those designs which require a high pressure to perform well.

If you have an un-pressurised system then you will need to calculate the head of hot water available to you before looking at our recommended minimum operating pressure and making your selection; – taking into consideration the route, any bends or diversions in the pipe work could reduce the pressure. If needed, contact your plumber for professional advice.

Water pressure is measured in the unit bar (also termed 'head') which is the distance from a presumed water tank to the tap in height +10 (1 bar = 10 metres head of water).

Pumps to boost water pressure can be purchased from all good DIY and plumbing retailers, should your tap of choice require a greater pressure than your system offers.

*If you live on a higher floor or your water supply comes from a private supply then check the minimum hot/cold water supply suitability.



* We offer a lifetime finish guarantee on our stainless steel taps.

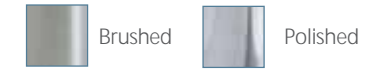

stainless steel
single lever/quarter turn

Voyager



- | | |
|----------------------|--------------------|
| Features | Dimensions: |
| High Pressure 0.5 | 162 x 210 x 130mm |
| Single Flow | |
| Swivel Body | |
| Available in: | |
| Polished TP0725 | |
| Brushed TP0720 | |

Vanquish



- | | |
|----------------------|--------------------|
| Features | Dimensions: |
| High Pressure 0.5 | 262 x 180 x 180mm |
| Single Flow | |
| Swivel Body | |
| Available in: | |
| Polished TP0724 | |
| Brushed TP0719 | |

Viceroy



- | | |
|----------------------|--------------------|
| Features | Dimensions: |
| High Pressure 0.5 | 258 x 180 x 180mm |
| Single Flow | |
| Swivel Body | |
| Available in: | |
| Polished – TP0723 | |
| Brushed – TP0718 | |

Vanguard



- | | |
|----------------------|--------------------|
| Features | Dimensions: |
| High Pressure 0.5 | 385 x 190 x 300mm |
| Single Flow | |
| Available in: | |
| Polished – TP0728 | |
| Brushed – TP0753 | |

Vortex



- | | |
|----------------------|--------------------|
| Features | Dimensions: |
| High Pressure 0.5 | 375 x 190 x 250mm |
| Single Flow | |
| Available in: | |
| Polished – TP0729 | |
| Brushed – TP0722 | |

Victory



- | | |
|----------------------|--------------------|
| Features | Dimensions: |
| Med Pressure 0.3 | 401 x 190 x 300mm |
| Single Flow | |
| Quarter Turn | |
| Available in: | |
| Polished – TP0727 | |
| Brushed – TP0702 | |

Valiant



- | | |
|----------------------|--------------------|
| Features | Dimensions: |
| Med Pressure 0.3 | 401 x 190 x 300mm |
| Single Flow | |
| Quarter Turn | |
| Available in: | |
| Polished – TP0726 | |
| Brushed – TP0721 | |

Waterloo



- | | |
|----------------------|--------------------|
| Features | Dimensions: |
| High Pressure 1.0 | 370 x 180 x 238mm |
| Single Flow | |
| Quarter Turn | |
| Available in: | |
| Polished – TP0756 | |
| Brushed – TP0755 | |

Varon



- | | |
|----------------------|--------------------|
| Features | Dimensions: |
| High Pressure 0.5 | 353 x 182 x 225mm |
| Single Flow | |
| Available in: | |
| Brushed – TP0778 | |

contemporary
single lever/quarter turn

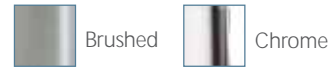

Leda



Features
 High Pressure 0.5
 Single Flow

Dimensions:
 492 x 213 x 320mm

Available in:
 Chrome – TP0775
 Brushed – TP0776

Elera



Features
 High Pressure 0.5
 Single Flow

Dimensions:
 361 x 203 x 250mm

Available in:
 Chrome – TP0771
 Brushed – TP0772

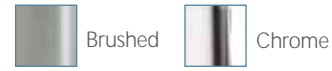

Indus



Features
 High Pressure 0.5
 Single Flow
 /Waterfall

Dimensions:
 345 x 162 x 245mm

Available in:
 Chrome – TP0717
 Brushed – TP0773

Orinoco



Features
 High Pressure 0.5
 Single Flow
 /Waterfall

Dimensions:
 320 x 200 x 245mm

Available in:
 Chrome – TP0716
 Brushed – TP0790

Tybers



Features
 High Pressure 0.5
 Single Flow

Dimensions:
 320 x 220 x 245mm

Available in:
 Chrome – TP0715



Izar



Features
 Med Pressure 0.3
 Single Flow/Waterfall
 Quarter Turn

Dimensions:
 344 x 179 x 264mm

Available in:
 Chrome – TP0769
 Brushed – TP0770

Planar



Features
 Low Pressure 0.1
 Single Flow/Waterfall
 Quarter Turn

Dimensions:
 390 x 206 x 281mm

Available in:
 Chrome – TP0611
 Brushed – TP0774

Conforto



Features
 High Pressure 1.0
 Single Flow
 Pull-Out Spray

Dimensions:
 364 x 190 x 200mm

Available in:
 Chrome – TP0448
 Brushed – TP0449

contemporary
single lever/quarter
turn/pull-out



Serenita



Features
 High Pressure 0.5
 Single Flow

Dimensions:
 303 x 217 x 212mm

Available in:
 Chrome – TP0450
 Brushed – TP0451

Ellipse



Features
 High Pressure 0.5
 Single Flow

Dimensions:
 270 x 217 x 245mm

Available in:
 Chrome – TP0779

Ellipse Pull-Out



Features
 High Pressure 1.0
 Single Flow
 Pull-Out Spray

Dimensions:
 283 x 218 x 251mm

Available in:
 Chrome – TP0780

Agena



Features
 Med Pressure 0.3
 Single Flow
 Quarter Turn

Dimensions:
 379 x 203 x 255mm

Available in:
 Chrome – TP0767
 Brushed – TP0768

Solent



Features
 High Pressure 0.5
 Single Flow

Dimensions:
 375 x 225 x 190mm

Available in:
 Chrome – TP0358

Arvus



Features
 High Pressure 0.5
 Single Flow

Dimensions:
 330 x 225 x 180mm

Available in:
 Chrome – TP0369

Axial Tower



Features
 High Pressure 0.5
 Single Flow

Dimensions:
 330 x 220 x 186mm

Available in:
 Chrome – TP0390

contemporary
single lever/quarter turn/pull-out

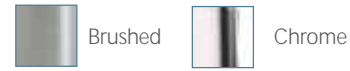

Ariel **FT**
Feature Tap



Features
■ High Pressure 0.5
■ Single Flow

Dimensions:
190 x 217 x 146mm

Available in:
 Chrome – TP0603
 Brushed – TP0604

Ariel Pull-Out



Features
■ High Pressure 1.0
■ Single Flow
■ Pull-Out Spray

Dimensions:
192 x 213 x 139mm

Available in:
 Chrome – TP0757
 Brushed – TP0758

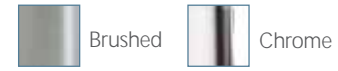

Shannon



Features
■ Low Pressure 0.1
■ Single Flow
■ Quarter Turn

Dimensions:
357 x 169 x 249mm

Available in:
 Chrome – TP0420
 Brushed – TP0788

Shannon Pull-Out



Features
■ High Pressure 0.5
■ Single Flow
■ Pull-Out Spray
■ Quarter Turn

Dimensions:
357 x 173 x 231mm

Available in:
 Chrome – TP0421
 Brushed – TP0789



contemporary
single lever/quarter turn



Axial



Features
■ High Pressure 0.5
■ Single Flow

Dimensions:
375 x 220 x 280mm

Available in:
 Chrome – TP0391

Tigris



Features
■ High Pressure 0.5
■ Single Flow
■ Swivel Body

Dimensions:
203 x 231 x 172mm

Available in:
 Chrome – TP0411

professional
single lever/pull-out/
directional



professional

Extendable hoses, and pull-out spray heads provide superlative control of water in the sink area; making cleansing, rinsing and food preparation as easy as for the professional chef.

Nordic Professional



Features
■ High Pressure 1.0
■ Single Flow
■ Pull-Out Spray

Dimensions:
447 x 220 x 200mm

Available in:
 Chrome – TP0704

V Form



Features
■ Low Pressure 0.1
■ Single Flow
■ Lever Turn

Dimensions:
377 x 210 x 279mm

Available in:
 Chrome – TP0759
 Brushed – TP0760



Elbe



Features
■ High Pressure 0.5
■ Single Flow

Dimensions:
311 x 215 x 161mm

Available in:
 Chrome – TP0412



Professional



Features
■ High Pressure 1.0
■ Single Flow
■ Pull-Out Spray

Dimensions:
355 x 231 x 225mm

Available in:
 Chrome – TP0700

Professionale



Features
■ High Pressure 1.0
■ Single Flow
■ Directional Spray

Dimensions:
885 x 260 x 295mm

Available in:
 Brushed – TP0459

classic quarter/lever turn

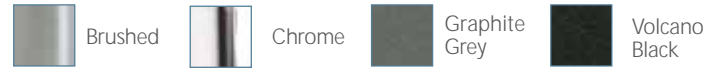

classic

Classic styling, with a host of different designs; the classic taps are elegant and offer ease-of-use, including pull-out option and quarter turn.



Danube



Features	Dimensions:
Med Pressure 0.3	320 x 215 x 204mm
Single Flow	
Quarter Turn	
Available in:	
	Chrome – TP0714

X Form



Features	Dimensions:
Low Pressure 0.1	378 x 216 x 278mm
Single Flow	
Quarter Turn	
Available in:	
	Chrome – TP0444
	Brushed – TP0445



These colours are available in the Targa Tap only.

Targa



Features	Dimensions:
Low Pressure 0.1	238 x 225 x 205mm
Single Flow	
Quarter Turn	
Available in:	
	Chrome – TP0021
	Brushed – TP0355
	White – TP0019
	Champagne – TP0024
	Opal White – TP0333
	Island Sand – TP0334
	Smokestone – TP0330



Shannon Bridge



Features	Dimensions:
Low Pressure 0.1	410 x 213 x 272mm
Single Flow	
Quarter Turn	
Available in:	
	Chrome – TP0744

Finesse Pull-Out



Features	Dimensions:
High Pressure 1.0	185 x 224 x 126mm
Single Flow	
Pull-Out Spray	
Available in:	
	Chrome – TP0259
	Brushed – TP0710

Finesse



Features	Dimensions:
High Pressure 0.5	168 x 231 x 136mm
Single Flow	
Available in:	
	Chrome – TP0135
	Brushed – TP0709
	Volcano Black – TP0484

Ocean



Features	Dimensions:
Low Pressure 0.1	343 x 200 x 223mm
Single Flow	
Quarter Turn	
Available in:	
	Chrome – TP0437
	Brushed – TP0438

classic/traditional quarter turn/compression

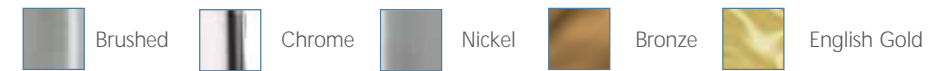

Ocean 3-Piece



Features	Dimensions:
High Pressure 0.5	312 x 159 x 212mm
Single Flow	
Quarter Turn	
Available in:	
	Chrome – TP0425
	Brushed – TP0752

Colonial Bridge



Features	Dimensions:
Low Pressure 0.1	364 x 185 x 237mm
Dual Flow	
Quarter Turn	
Available in:	
	Chrome – TP0389
	English Gold – TP0388



Jordan



Features	Dimensions:
Low Pressure 0.1	367 x 193 x 237mm
Dual Flow	
Quarter Turn	
Available in:	
	Chrome – TP0413
	Brushed – TP0414



Colonial Monobloc



Features	Dimensions:
Low Pressure 0.1	382 x 193 x 252mm
Dual Flow	
Quarter Turn	
Available in:	
	Chrome – TP0328
	English Gold – TP0326

Camargue Monobloc



Features	Dimensions:
Low Pressure 0.1	240 x 250 x 178mm
Single Flow	
Compression	
Available in:	
	Chrome – TP0327
	Bronze – TP0034
	Nickel – TP0035

Camargue Bridge



Features	Dimensions:
Low Pressure 0.1	259 x 250 x 198mm
Single Flow	
Compression	
Available in:	
	Chrome – TP0430
	Bronze – TP0037
	Nickel – TP0039
	Gold – TP0038

colour match
single lever/directional



Colour Match Range

Our stunning range of unique colour matched designs allow you to match the tap with our Volcano Black sinks.

These distinctive designs also look great against dark laminate worktops!

Indus FT
Feature Tap



Features	Dimensions:
High Pressure 0.5 Single Flow /Waterfall	Available in: Chrome/ Volcano Black TP0761



Springflow® taps



tap colours and finishes

Targa



Features	Dimensions:
Low Pressure 0.1 Dual Flow Quarter Turn	238 x 225 x 205mm
Available in:	
Chrome – TP0416 Brushed – TP0482	

Jordan



Features	Dimensions:
Low Pressure 0.1 Dual Flow Quarter Turn	367 x 193 x 237mm
Available in:	
Chrome – TP0440 Brushed – TP0441	

Finishes

	Brushed		Chrome
	Polished		Nickel
	English Gold		Bronze

Tybers



Features	Dimensions:
High Pressure 0.5 Single Flow	320 x 220 x 245mm
Available in:	
Chrome/ Volcano Black TP0762	

Ariel



Features	Dimensions:
High Pressure 0.5 Single Flow	190 x 217 x 146mm
Available in:	
Chrome/ Volcano Black TP0763	

Professional



Features	Dimensions:
High Pressure 1.0 Single Flow Pull-Out Spray	355 x 231 x 225mm
Available in:	
Chrome/ Volcano Black TP0764	

Ariel



Features	Dimensions:
High Pressure 1.0 Single Flow	190 x 217 x 146mm
Available in:	
Chrome – TP0781 Brushed – TP0782	

Vida



Features	Dimensions:
Med Pressure 0.3 Separate Flow Quarter Turn	310 x 180 x 204mm
Available in:	
Brushed – TP0765	

Colours

	Graphite Grey		Volcano Black
	Opal White		White
	Smokestone		Island Sand
	Champagne		

TAP SUPPORT BRACKET

Order code: TP0431
(Standard)

Order code: TP0518
(Pull-Out Taps)

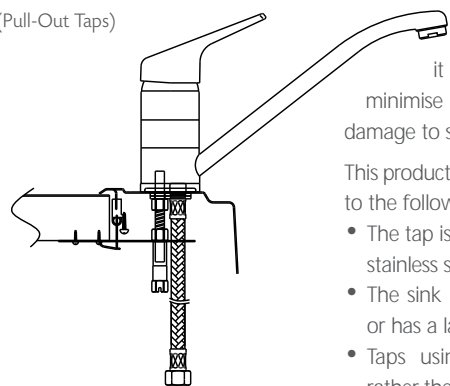

On occasion, depending on the type of sink and weight of the tap being fitted, a tap may require additional support. This product is designed to reduce the amount of sway of the tap when it is being used and to minimise any potential long term damage to sinks, taps or pipe work. This product is particularly applicable to the following conditions:

- The tap is fitted to a budget inset stainless steel sink.
- The sink is a single bowl model, or has a large drainer section.
- Taps using flexible connectors rather than rigid copper tail pipes.



Finesse



Features	Dimensions:
Med Pressure 0.3 Dual Flow	168 x 231 x 136mm
Available in:	
Chrome – TP0474 Brushed – TP0475	

Colonial



Features	Dimensions:
Low Pressure 0.1 Dual Flow Quarter Turn	382 x 193 x 252mm
Available in:	
Chrome – TP0415 English Gold – TP0483	



CHOOSE TASTE

Making and keeping water safe means water companies have to use chemicals like chlorine that can significantly affect taste and odour. In addition natural sediment and other non-harmful contaminants can end up making our water taste and look anything but fresh.

Springflow®, however, transforms this into natural fresh tasting and odourless water that is a sheer pleasure to drink!

Springflow® filter taps combat odours and contaminants in your water supply to improve the appearance and taste of tap water, dramatically reducing chlorine by up to 99%.

Your Springflow Filter will reduce:

- Chlorine
- Sediment
- Pesticides
- Dirt
- Solvents
- Rust

To give you fresh, crystal clear natural tasting filtered water in your own home.

CHOOSE HEALTH

Water is an essential component of life. We can't live without it.

In the UK we take it for granted that we have safe drinking water on tap. Springflow® goes even further; combating herbicides, pesticides, insecticides and other organic chemicals – making it not just taste better but healthier too!

CHOOSE SPRINGFLOW®

You can't choose the quality or source of your tap water, but with a Springflow® filter tap you can transform your normal mains supply into fresh, natural tasting filtered water – at the touch of a handle.

Springflow® filter taps give additional protection against chemicals that may be present in the mains supply, reducing chlorine by up to 99% and filtering out sediment, dirt and rust whilst leaving the minerals essential to good health.



Springflow® pure filtered water



At the turn of a handle Springflow® taps dispense an endless supply of refreshing crystal clear water, it couldn't be easier!

CHOOSE SIMPLICITY

Our patented valve system means there is no need for additional handles or fuss – just push the cold handles back to dispense fresh filtered water.

Our filter, hidden away under the sink can be mounted in any position, horizontal or vertical – to best fit the space you have to offer. When it comes to changing the filter you don't need a new unit just open up the discreet casing and pop in a new cartridge. No mess, no hassle, just great tasting water.

- Springflow® enhances the taste of soft drinks, tea, coffee and even food, when used for cooking.
- Springflow® reduces the build-up of lime scale extending the life of appliances including kettles.
- Springflow® treats up to 2,500 litres of water, around six months use, with just one cartridge.

CHOOSE ECONOMY

A typical bottle of water would cost up to 30 x more than Springflow® filtered water, and with Springflow® there is no plastic waste.

CHOOSE DESIGN...

Our current range features a tap for every kitchen.

Springflow®



Nordic Multi Professional Tap

sink specifications



Stainless Steel

Profile 1.0 Bowl

C/W brushed square waste & overflow

Min Base Unit	600mm
Depths/Capacity	Main Bowl 162 / 26L
Finish available - Brushed Steel	
1.0B LHD with Planar Tap	PR10XBHOMEPK1
1.0B RHD with Planar Tap	PR10XBHOMEPKR1

1.0B LHD with Indus Tap	PR10XBHOMEPK2
1.0B RHD with Indus Tap	PR10XBHOMEPKR2
Inset > Left and Right Hand Drainer	

Optional Accessories

Glass Chopping Board
Drainer/Defrosting Tray & Colander PRXBACCPK

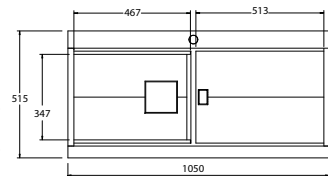

CUTOUT 1030 x 495mm

Profile 1.5 Bowl

C/W brushed square wastes & pipe work

Min Base Unit	600mm
Depths/Capacity	Main Bowl 166 / 21L Half Bowl 142 / 8L
Finish available - Brushed Steel	
1.5B LHD with Planar Tap	PR15XBHOMEPK1
1.5B RHD with Planar Tap	PR15XBHOMEPKR1

1.5B LHD with Indus Tap	PR15XBHOMEPK2
1.5B RHD with Indus Tap	PR15XBHOMEPKR2
Inset > Left and Right Hand Drainer	

Optional Accessories

Glass Chopping Board
Drainer/Defrosting Tray & Colander PRXBACCPK

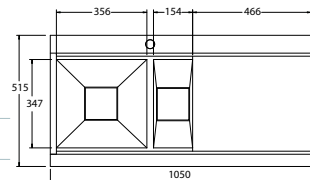

CUTOUT 1030 x 495mm

Vantage 1.0 Bowl

C/W chrome covered pop up waste, covered overflow & bowl grid

Min Base Unit	600mm
Depths/Capacity	Main Bowl 190 / 35.7L
Finish available	
Brushed Steel LHD	VN10XBHOMESKL
Brushed Steel RHD	VN10XBHOMESKR
Inset > Left and Right Hand Drainer	

Optional Accessories

Chopping Board 51 - Mahogany NEXCB92

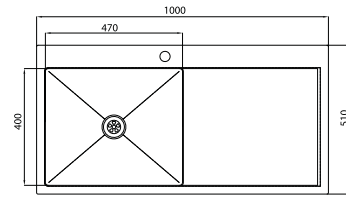

CUTOUT 980 x 490mm

Vantage 1.5 Bowl

C/W chrome covered pop up wastes, covered overflows & bowl grid

Min Base Unit	600mm
Depths/Capacity	Main Bowl 190 / 25L Half Bowl 160 / 10L
Finish available	
Brushed Steel LHD	VN15XBHOMESKL
Brushed Steel RHD	VN15XBHOMESKR
Inset > Left and Right Hand Drainer	

Optional Accessories

Chopping Board 51 - Mahogany NEXCB92

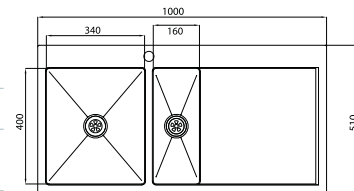

CUTOUT 980 x 490mm

Bistro 1.0 Bowl

C/W chrome waste, overflow, grid & Glass C/board (boxed)

Min Base Unit	1000mm
Depths/Capacity	Main Bowl 166 / 23L
Finish available	
Brushed Steel LHD	DE10XBHOMEPKL
Brushed Steel RHD	DE10XBHOMEPKR
Inset > Left and Right Hand Drainer	

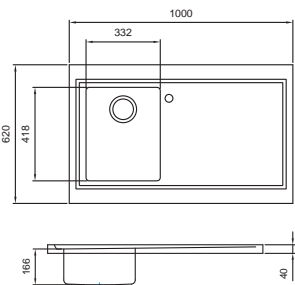

Bistro 1.5 Bowl

C/W chrome wastes, pipe work, grid, Glass C/board & Colander (boxed)

Min Base Unit	1000mm
Depths/Capacity	Main Bowl 166 / 23L Half Bowl 110 / 5L
Finish available	
Brushed Steel LHD	DE15XBHOMEPKL
Brushed Steel RHD	DE15XBHOMEPKR
Inset > Left and Right Hand Drainer	

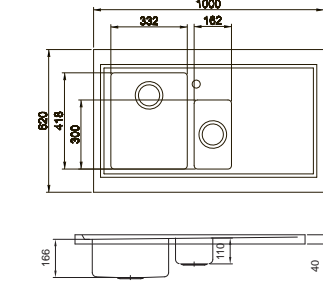

Olympus 1.0 Bowl

C/W chrome waste, overflow & Pack A (boxed)

Min Base Unit	800mm
Depths/Capacity	Main Bowl 200 / 59L
Finishes available	
Polished Steel	OL10XXHOMESK
Inset > Non Reversible	

Accessories Packs

Pack A - Large steel bowl, steel drainer BKOLPACKA
Pack B - Steel round bowl, round colander, c/board & glass food prep board BKOLPACKB
Pack C - Steel drainer tray / plate rack cutlery basket BKOLPACKC

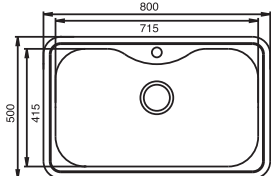

CUTOUT 780 x 480mm
Corner radiuses 50mm



Belfast 1.0 Bowl

C/W chrome waste, overflow & bowl grid (boxed)

Min Base Unit	Bespoke Base Unit
Depths/Capacity	Main Bowl 254 / 47L
Finish available	
Brushed Steel	BEXBHOMEPK
Inset >	

Optional Accessories

Glass Chopping Board
Grid & Demi Drainer BF10XBACCPK

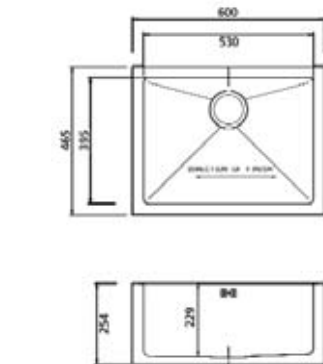

Lausanne 1.0 Bowl

C/W chrome waste & overflow (boxed)

Min Base Unit	500mm
Depths/Capacity	Main Bowl 171 / 24L
Finish available	
Polished Steel LHD	LW10XXHOMESKL
Polished Steel RHD	LW10XXHOMESKR
Inset > Left and Right Hand Drainer	

Optional Accessories

Main basket & LHD Grid - Stainless Steel LW10ACCPKLHD
Main basket & RHD Grid - Stainless Steel LW10ACCPKRHD

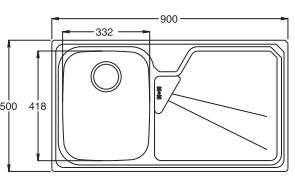

CUTOUT 880 x 480mm



Lausanne 1.5 Bowl

C/W chrome wastes, pipe work & colander (boxed)

Min Base Unit	600mm
Depths/Capacity	Main Bowl 171 / 24L Half Bowl 120 / 6L
Finish available	
Polished Steel LHD	LW15XXHOMESKL
Polished Steel RHD	LW15XXHOMESKR
Inset > Left and Right Hand Drainer	

Optional Accessories

Main basket, LH Drainer Grid and Glass Chopping Board LW15ACCPKLHD
Main basket, RH Drainer Grid & Glass Chopping Board LW15ACCPKRHD

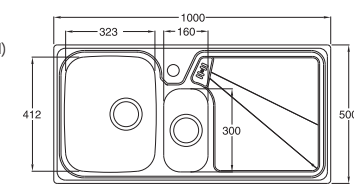

CUTOUT 980 x 480mm



Echo 1.0 Bowl

C/W chrome waste & overflow (boxed)

Min Base Unit	600mm
Depths/Capacity	Main Bowl 194 / 40L
Finish available	
Brushed Steel LH	EH10XXHOMESKL
Brushed Steel RH	EH10XXHOMESKR
Inset > Left and Right Hand Drainer	

Optional Accessories Pack

Grid, Glass Chopping Board & Colander EH10ACCPK

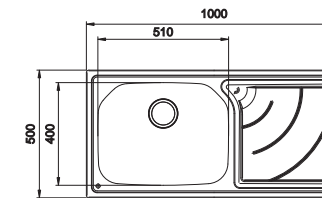

CUTOUT 980 x 480mm



Echo 1.5 Bowl

C/W chrome wastes, overflow & pipe work (boxed)

Min Base Unit	600mm
Depths/Capacity	Main Bowl 194 / 27L Half Bowl 115 / 6L
Finish available	
Brushed Steel LHD	EH15XXHOMESKL
Brushed Steel RHD	EH15XXHOMESKR
Inset > Left and Right Hand Drainer	

Optional Accessories Pack

Grid, Glass Chopping Board and Colander EH15ACCPK

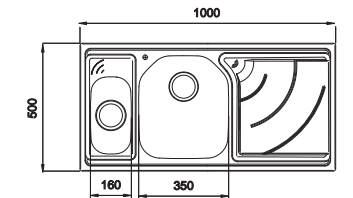

CUTOUT 980 x 480mm



Korona 1.0 Bowl

C/W chrome waste & overflow (boxed)

Min Base Unit	600mm
Depths/Capacity	Main Bowl 200 / 34.6L
Finish available	
Polished Steel	KO10XXHOMESK
Inset > Reversible	

Optional Accessories

Grid & Chopping board KO10ACCPK1

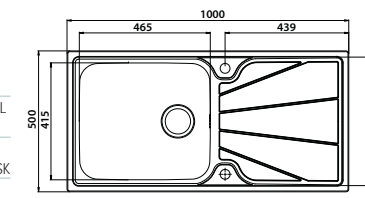

CUTOUT 980 x 480mm



Korona 1.0 Bowl

Korona 1.5 Bowl

C/W chrome wastes, overflow, & pipe work (boxed)

Min Base Unit	600mm
Depths/Capacity	Main Bowl 175 / 22.5L Half Bowl 120 / 6L
Finishes available	
Polished Steel	KO15XXHOMESK
Inset > Reversible	

Optional Accessories

Grid, Colander & Chopping board KO15ACCPK1

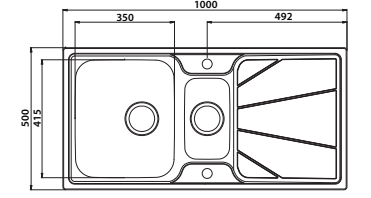

CUTOUT 980 x 480mm

Minimum tap reach 160mm



Montreux 1.0 Bowl

C/W chrome waste, overflow & pipe work (boxed)

Min Base Unit	500mm
Depths/Capacity	Main Bowl 175 / 22.5L
Finish available	
Brushed	MX10XBHOMESK
Inset > Reversible	

Optional Accessories

Grid & Chopping Board KO10ACCPK1

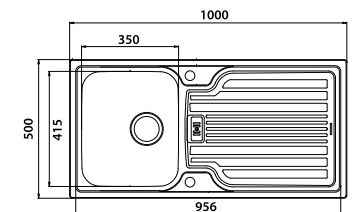

CUTOUT 980 x 480mm



Montreux 1.5 Bowl

C/W chrome wastes, overflow, colander & pipe work (boxed)

Min Base Unit	600mm
Depths/Capacity	Main Bowl 175 / 22.5L Half Bowl 120 / 6L
Finish available	
Brushed	MX15XBHOMESK
Inset > Reversible	

Optional Accessories

Grid & Chopping Board KO10ACCPK1

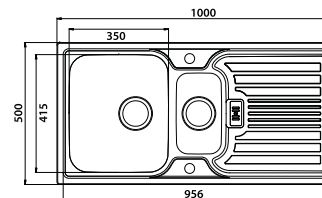

CUTOUT 980 x 480mm

Minimum tap reach 120mm



Topaz 1.0 Bowl

C/W chrome waste, overflow (boxed)

Min Base Unit	500mm
Depths/Capacity	Main Bowl 171 / 24L
Finishes available	
Polished Steel	TP10XXHOMESK
Inset > Reversible	

Optional Accessories

Main basket & drainer - Stainless Steel BK49XXHOME
Wooden Chopping Board - Beech CB85XXHOME

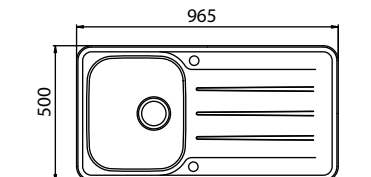

CUTOUT 945 x 480mm



Topaz 1.5 Bowl

C/W chrome wastes & pipe work (boxed)

Min Base Unit	600mm
Depths/Capacity	Main Bowl 171 / 24L Half Bowl 121 / 6L
Finishes available	
Polished Steel	TP15XXHOMESK
Inset > Reversible	

Optional Accessories

Main basket, drainer, colander - Stainless Steel BK67XXHOME
Wooden Chopping Board - Beech CB85XXHOME

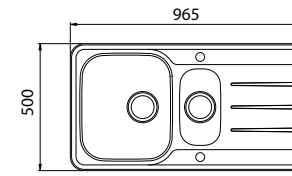

CUTOUT 945 x 480mm

Minimum tap reach 160mm



Alto 1.0 Bowl

C/W chrome waste & overflow (boxed)

Min Base Unit	500mm
Depths/Capacity	Main Bowl 165 / 24L
Finishes available	
Brushed Steel	A010XBHOMESK
Linon	A010XLHOMESK
Inset > Reversible	

Optional Accessories

Large basket, drainer - Stainless Steel BK49XXHOME
Large basket, drainer - White Only BK42WHHOME
Chopping Board 20 - Beech CB85XXHOME

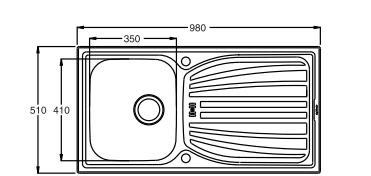

CUTOUT 960 x 490mm

Stainless Steel

Alto 1.5 Bowl

C/W chrome wastes & pipe work (boxed)

Min Base Unit	600mm
Depths/Capacity	Main Bowl 165 / 24L Half Bowl 120 / 6L

Colours available	ROK® Metallic
Brushed Steel	A015XBHOMESK
Linen	A015XLHOMESK

Inset > Reversible

Optional Accessories

Large basket, drainer, colander - Stainless Steel	BK67XXHOME
Large basket, drainer, colander - White Only	BK43WHHOME
Chopping Board 20 - Beech	CB85XXHOME

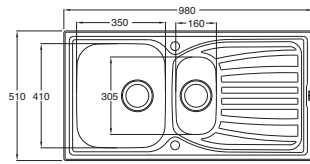

CUTOUT 960 x 490mm

Orb Round Bowl & Vida Tap

C/W chrome pop-up waste (boxed)

Min Base Unit	400mm
Depths/Capacity	Main Bowl 130 / 4.8L

Colours available	ROK® Metallic
Brushed Steel Sink	OB10XBHOMESK
Brushed Steel Tap	TP0765
Sink & Tap Pack	OB10XBHOMEPK

Inset or Undermounted >

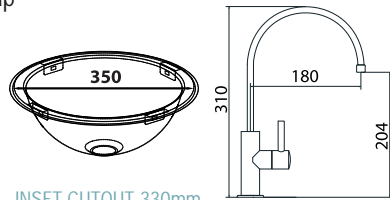

INSET CUTOUT 330mm
U/M CUTOUT 290mm

Composite

Ellipse 1.0 Bowl

C/W chrome covered pop-up waste, covered overflow (boxed)

Min Base Unit	600mm
Depths/Capacity	Main Bowl 172 / 28L

Colours available	ROK® Metallic
Volcano Black	RHD EP10RZHOMESKR
Graphite Grey	RHD EP10RXHOMESKR
Chocolate Metallic	RHD EP10ROHOMESKR
Volcano Black	LHD EP10RZHOMESKL
Graphite Grey	LHD EP10RXHOMESKL
Chocolate Metallic	LHD EP10ROHOMESKL

Colours available	Granite ROK®
Sahara Beige	RHD EP10RHOMESKR
Opal White	RHD EP10RWHOMESKR
Sahara Beige	LHD EP10RHOMESKL
Opal White	LHD EP10RWHOMESKL

Inset > Left or Right Handed Drainer

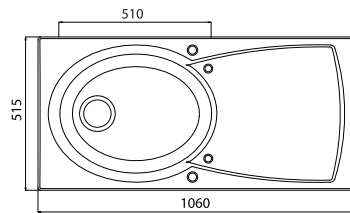

CUTOUT 1036 x 491mm

Geo 1.0 Bowl

C/W brushed square pop-up waste & overflow (boxed)

Min Base Unit	600mm
Depths/Capacity	Main Bowl 171 / 31L

Colours available	ROK® Metallic
Volcano Black	GE10RZHOMESK
Graphite Grey	GE10RXHOMESK
Chocolate Metallic	GE10ROHOMESK

Colours available	Granite ROK®
Sahara Beige	GE10RHOMESK

Inset > Reversible

Optional Accessories Pack

Grid, Colander and Glass Chopping Board	GE10ACCPK
---	-----------

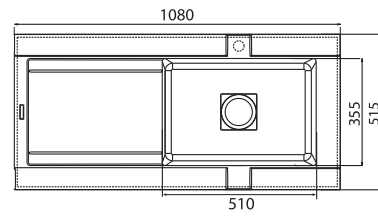

CUTOUT 1056 x 491mm



Geo 1.5 Bowl

C/W brushed square pop-up waste, square waste & pipe work (boxed)

Min Base Unit	600mm
Depths/Capacity	Main Bowl 165 / 24L Half Bowl 126 / 8L

Colours available	ROK® Metallic
Volcano Black	LH GE15RZHOMESKL
Volcano Black	RH GE15RZHOMESKR
Graphite Grey	LH GE15RXHOMESKL
Graphite Grey	RH GE15RXHOMESKR
Chocolate Metallic	LH GE15RQHOMESKL
Chocolate Metallic	RH GE15RQHOMESKR

Colours available	Granite ROK®
Sahara Beige	LH GE15RHOMESKL
Sahara Beige	RH GE15RHOMESKR

Inset > Left or Right Handed Drainer

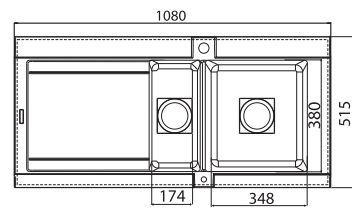

CUTOUT 1056 x 491mm



Optional Accessories Pack

Grid, Colander and Glass Chopping Board	GE15ACCPK
---	-----------

Helix 1.0 Bowl

C/W brushed square pop-up waste & overflow (boxed)

Min Base Unit	600mm
Depths/Capacity	Main Bowl 200 / 59L Half Bowl 150 / 11L

Colours available	ROK® Metallic
Volcano Black	LO15RZHOMESK
Graphite Grey	LO15RXHOMESK
Chocolate Metallic	LO15RQHOMESK

Colours available	Granite ROK®
Sahara Beige	LO15RHOMESK

Inset > Reversible

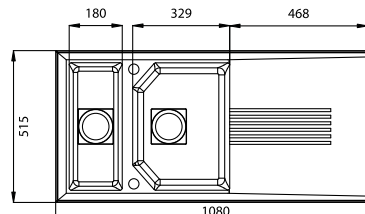

CUTOUT 1056 x 491mm



Optional Accessories Pack

Grid, Colander and Glass Chopping Board	LO15ACCPK
---	-----------

Lausanne 1.0 Bowl

C/W chrome waste, overflow & pipe work (boxed)

Min Base Unit	500mm
Depths/Capacity	Main Bowl 170 / 24L

Colours available	ROK® Metallic
Volcano Black	LHD LU10RZHOMESKL
Volcano Black	RHD LU10RZHOMESKR
Graphite Grey	LHD LU10RXHOMESKL
Graphite Grey	RHD LU10RXHOMESKR

Inset > Left or Right Handed Drainer

Optional Accessories

Main basket & LHD Grid - Stainless Steel	LU10ACCPKLHD
Main basket & RHD Grid - Stainless Steel	LU10ACCPKRHD

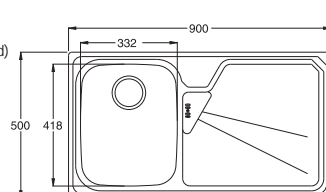

CUTOUT 884 x 484mm



Optional Accessories Pack

Grid, Colander and Glass Chopping Board	LO10ACCPK
---	-----------

Composite

Lausanne 1.5 Bowl

C/W chrome wastes, overflow, colander & pipe work (boxed)

Min Base Unit	600mm
Depths/Capacity	Main Bowl 170 / 23L Half Bowl 115 / 6L

Colours available	ROK® Metallic
Volcano Black	LHD LU15RZHOMESKL
Volcano Black	RHD LU15RZHOMESKR
Graphite Grey	LHD LU15RXHOMESKL
Graphite Grey	RHD LU15RXHOMESKR

Inset > Left or Right Handed Drainer

Optional Accessories

Main basket, LH Drainer Grid & Glass Chopping Board	LU15ACCPKLHD
Main basket, RH Drainer Grid & Glass Chopping Board	LU15ACCPKRHD

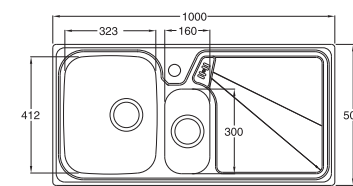

CUTOUT 976 x 476mm

Korona 1.0 Bowl

C/W chrome waste, overflow & pipe work (boxed)

Min Base Unit	600mm
Depths/Capacity	Main Bowl 232 / 49L

Colours available	ROK® Metallic
Volcano Black	KO10RZHOMESK
Graphite Grey	KO10RXHOMESK

Colours available	Granite ROK®
Opal White	KO10RWHOMESK
Island Sand	KO10RIHOMESK
Sylvanite Grey	KO10RYHOMESK

Inset > Reversible

Optional Accessories

Main Basket & Drainer - Stainless Steel	KO10ACCPK
Wooden Chopping Board 14 - Beech	CB0070XXHOME
Premium Accessory Pack	KO10PREMACCPK

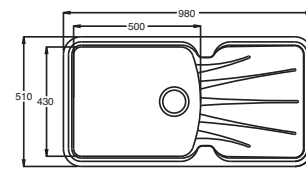

CUTOUT 956 x 486mm
Corner radiuses 58mm



Korona 2.0 Bowl

C/W chrome wastes & pipe work (boxed)

Min Base Unit	800mm
Depths/Capacity	Main Bowls 178 / 26L

Colours available	ROK® Metallic
Volcano Black	KO20RZHOMESK
Graphite Grey	KO20RXHOMESK

Colours available	Granite ROK®
Opal White	KO20RWHOMESK
Island Sand	KO20RIHOMESK
Sylvanite Grey	KO20RYHOMESK

Inset > Reversible

Optional Accessories

Main Basket & Drainer - Stainless Steel	KOMX15ACCPK
Wooden Chopping Board 14 - Beech	CB0070XXHOME
Premium Accessory Pack	KO10PREMACCPK

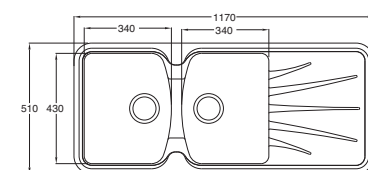

CUTOUT 1146 x 486mm
Corner radiuses 58mm

Vortex Round Bowl

C/W chrome covered pop-up waste & covered overflow (boxed)

Min Base Unit	500mm (inset) 600mm (undermount) 600mm (inset together, inc. overflow)
Depths/Capacity	Main Bowl 153 / 18L

Colours available	ROK® Metallic
Volcano Black	VX10RZHOMESK
Graphite Grey	VX10RXHOMESK
Chocolate Metallic	VX10RQHOMESK

Colours available	Granite ROK®
Sahara Beige	VX10RHOMESK

Inset or undermounted >



INSET CUTOUT 462mm
U/M CUTOUT 456mm

Vector 1.5 Bowl

C/W chrome wastes, overflow & pipe work (boxed)

Min Base Unit	800 Straight run or 900mm Corner unit
Depths/Capacity	Main Bowl 191 / 28L Half Bowl 100 / 4L

Colours available	ROK® Metallic
Volcano Black	VE15RZHOMESK
Graphite Grey	VE15RXHOMESK

Colours available	Granite ROK®
Opal White	VE15RWHOMESK
Island Sand	VE15RIHOMESK
Sylvanite Grey	VE15RYHOMESK

Inset > Non Reversible LH Drainer only

Optional Accessories

Main Bowl Basket	BK0499
Chopping Board 24 - Rubberwood	CB01XXHOME

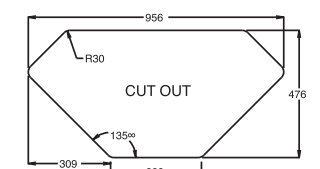
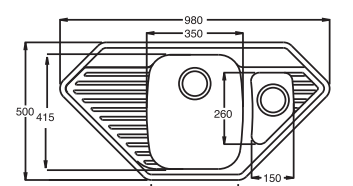

NB: This model will require a 750mm worktop when fitting to a corner unit.

Korona 1.5 Bowl

C/W chrome wastes & pipe work (boxed)

Min Base Unit	600mm
Depths/Capacity	Main Bowl 178 / 26L Half Bowl 108 / 5L

Colours available	ROK® Metallic
Volcano Black	KO15RZHOMESK
Graphite Grey	KO15RXHOMESK

Colours available	Granite ROK®
Opal White	KO15RWHOMESK
Island Sand	KO15RIHOMESK
Sylvanite Grey	KO15RYHOMESK

Inset > Reversible

Optional Accessories

Main Basket & Drainer - Stainless Steel	KOMX15ACCPK
Wooden Chopping Board 14 - Beech	CB0070XXHOME
Premium Accessory Pack	KO15PREMACCPK

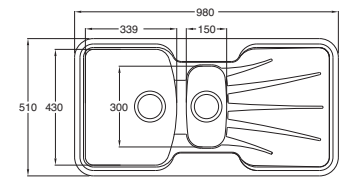

CUTOUT 956 x 486mm
Corner radiuses 58mm

Minimum tap reach 170mm



Cascade 1.0 Bowl

C/W chrome waste & overflow

Min Base Unit	450mm
Depths/Capacity	Main Bowl 180 / 15L

Colours available	ROK® Metallic
Volcano Black	CC10RZHOMESK
Chocolate Metallic	CC10ROHOMESK

Colours available	Granite ROK®
Sahara Beige	CC10RHOMESK

Inset > Reversible

Optional Accessories

Glass chopping board, wooden chopping board and colander	CC10ACCEXPCHK
--	---------------

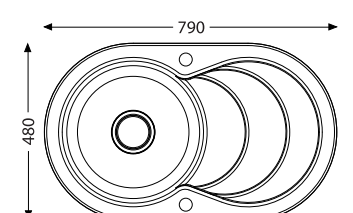

CUTOUT 766 x 456mm

Please note: *Due to material properties and the handmade manufacturing process dimensions may vary from guidelines below. We strongly recommend any cut outs to worktops are made based on your individual sink dimensions.

Essenza 1.5 Bowl

C/W chrome wastes, overflow & pipe work (boxed)

Min Base Unit	600mm
Depths/Capacity	Main Bowl 200 / 40L Half Bowl 75 / 5L
Colour available	
Matt White	EA15WHHONESK
Sit-In	»

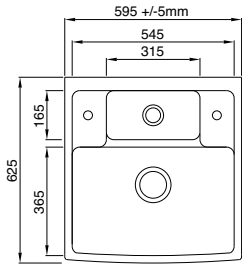

Onesto 1.5 Bowl

C/W chrome wastes, overflow & pipe work (boxed)

Min Base Unit	600mm
Depths/Capacity	Main Bowl 200 / 40L Half Bowl 75 / 0.4L
Colour available	
Matt White	0015WHNEXSKR
Matt White	0015WHNEXSKL
Inset	» Left or right handed drainer

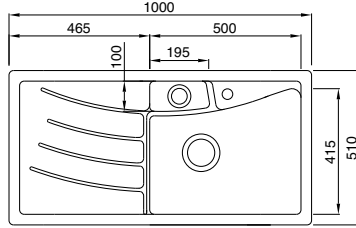

CUTOUT* 970 x 480mm

Geo 1.0 Bowl

C/W brushed square waste, overflow & pipe work (boxed)

Min Base Unit	600mm
Depths/Capacity	Main Bowl 200 / 33L
Colour available	
Matt White	GE10WHHONESK
Inset	» Reversible

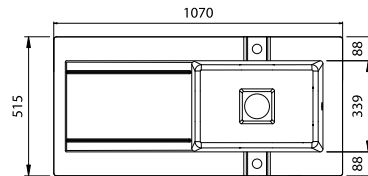

CUTOUT* 1046 x 491mm

Geo 1.5 Bowl

C/W brushed square waste, overflow & pipe work (boxed)

Min Base Unit	600mm
Depths/Capacity	Main Bowl 200 / 22L Half Bowl 156 / 9L
Colour available	
Matt White	GE15WHHONESK
Inset	» Reversible

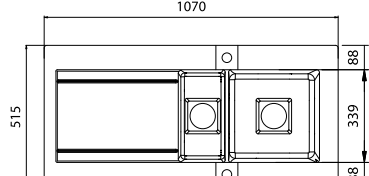

CUTOUT* 1046 x 491mm

Optional Accessories

Iroko Chopping Board	CB0126
Grid - Stainless Steel	BK0680

Optional Accessories

Iroko Chopping Board	CB0126
Grid - Stainless Steel	BK0681

Jersey 1.5 Bowl

C/W chrome wastes, overflow & pipe work (boxed)

Min Base Unit	1000mm
Depths/Capacity	Main Bowl 165 / 42L Half Bowl 130 / 6L
Colour available	
Gloss White	JE15WHHONESK
Gloss White	JE15WHHONESKR
Sit-In	» Left or right handed drainer

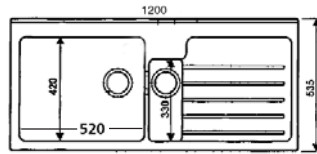

CUTOUT* 1176 x 511mm



Equinox 1.0 Bowl

C/W chrome waste & overflow (boxed)

Min Base Unit	600mm
Depths/Capacity	Main Bowl 190 / 34L
Colour available	
Gloss White	EQ10WHHONESK
Inset	» Reversible

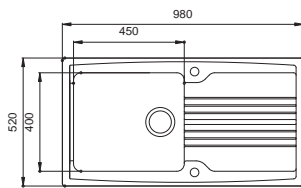

CUTOUT* 956 x 496mm

Equinox 1.5 Bowl

C/W chrome waste & pipe work (boxed)

Min Base Unit	600mm
Depths/Capacity	Main Bowl 180 / 22L Half Bowl 120 / 2L
Colour available	
Gloss White	EQ15WHHONESK
Inset	» Reversible

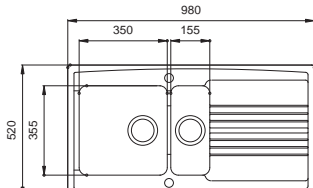

CUTOUT* 956 x 496mm

Edinburgh 1.0 Bowl

C/W chrome waste & overflow (boxed)

Min Base Unit	Bespoke Unit Required
Depths/Capacity	Main Bowl 190 / 46L
Colour available	
Gloss White	ED10WHHONESK
Sit-In	» Bow Front

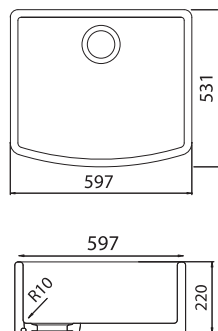

Aquitaine 1.0 Bowl

C/W chrome waste, overflow & pipe work (boxed)

Min Base Unit	500mm
Depths/Capacity	Main Bowl 168 / 28L
Colour available	
Gloss White	CR10WHHONESK
Inset	» Reversible

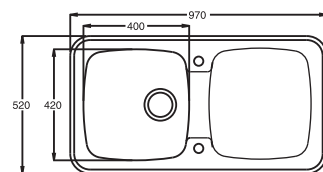

CUTOUT* 930 x 480mm
Corner radiuses 55mm

Optional Accessories

Basket and Drainer - White	BK24WHHOME
----------------------------	------------

Please note: *Due to material properties and the handmade manufacturing process dimensions may vary from guidelines below. We strongly recommend any cut outs to worktops are made based on your individual sink dimensions.

Aquitaine 1.5 Bowl

C/W chrome wastes & pipe work (boxed)

Min Base Unit	600mm
Depths/Capacity	Main Bowl 168 / 25L Half Bowl 120 / 4L
Colour available	
Gloss White	CR15WHHONESK
Inset	» Reversible

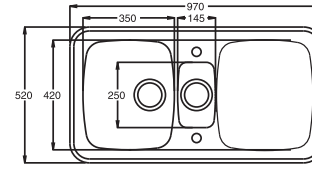

CUTOUT* 930 x 480mm
Corner radiuses 55mm
Minimum tap reach 120mm

Optional Accessories

Basket and Drainer - White	BK24WHHOME
----------------------------	------------

Butler Drainer

Min Base Unit	N/A
Depth	55mm
Colour available	
Gloss White	CRXWHRAINER
Sits on worktop	»

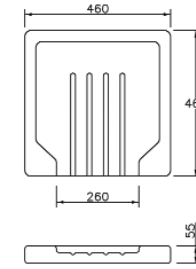

Sudbury 1.0 Bowl

C/W chrome plug & overflow (boxed)

Min Base Unit	Bespoke Unit Required
Depths/Capacity	Main Bowl 185 / 45L
Colour available	
Gloss White	SU10WHHONESK
Sit-In	»

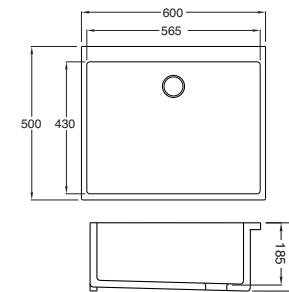

Belfast

C/W chrome plug (boxed)

Min Base Unit	Bespoke Unit Required
Depths/Capacity	Main Bowl 229 / 46L
Colour available	
Gloss White	BF10WHHONESK
Sit-In	»

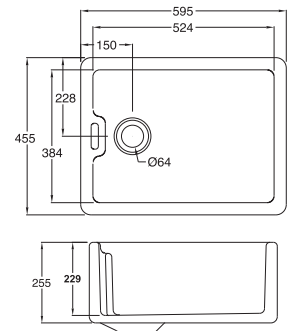

Canterbury 1.5 Bowl

C/W chrome waste & overflow (boxed)

Min Base Unit	Bespoke Unit Required
Depths/Capacity	Main Bowl 205 / 47L Half Bowl 135 / 0.2L
Colour available	
Gloss White	CA15WHHONESK
Sit-In	»

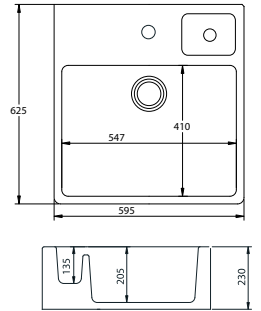

Minimum tap reach for 1/4 Bowl 240mm

Sudbury 2.0 Bowl

C/W chrome plugs & pipe work (boxed)

Min Base Unit	Bespoke Unit Required
Depths/Capacity	Main Bowls 230 / 47L
Colour available	
Gloss White	SU20WHHONESK
Sit-In	»

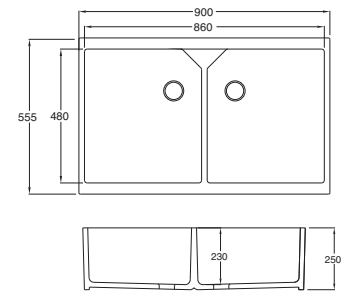

Undermounts – Steel

Edge H1 0.5 Bowl

C/W chrome waste

Min Base Unit	Any
Depths/Capacity	Half Bowl 120 / 5L
Finish available	
Polished	EDH1XXHONESK
Undermounted	»

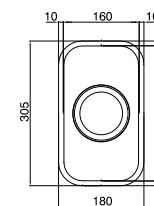

Undermount template supplied with sink

Edge S1 1.0 Bowl

C/W chrome waste, overflow & bowl grid (boxed)

Min Base Unit	450mm
Depths/Capacity	Main Bowl 175 / 25L
Finish available	
Polished	EDS1XXHONESK
Undermounted	»

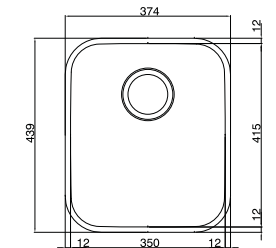

Included Accessories

Main bowl Grid - Stainless Steel

Undermount template supplied with sink

Edge S2 1.0 Bowl

C/W chrome waste, overflow & bowl grid (boxed)

Min Base Unit	600mm
Depths/Capacity	Main Bowl 200 / 35L
Finish available	
Polished	EDS2XXHONESK
Undermounted	»

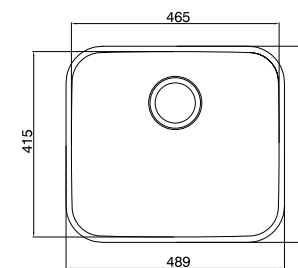

Included Accessories

Main bowl Grid - Stainless Steel

Undermount template supplied with sink

Edge D1 1.5 Bowl

C/W chrome waste, overflow & pipe work (boxed)

Min Base Unit	600mm
Depths/Capacity	Main Bowl 175 / 25L Half Bowl 120 / 5L
Finish available	
Polished	LHD EDD1XXHONESKL RHD EDD1XXHONESKR
Undermounted	»

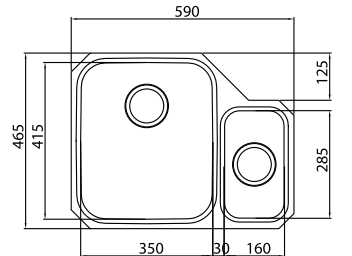

Included Accessories

Main bowl Grid - Stainless Steel

Undermount template supplied with sink



Echo H1 0.5 Bowl
C/W chrome waste (boxed)

Min Base Unit	Any
Depths/Capacity	Half Bowl 115 / 6L

Finish available	
Polished	EHH1XXHOMESK
Undermounted >	

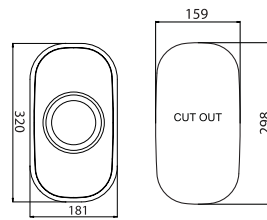

Undermount template supplied with sink

Echo S1 1.0 Bowl

C/W chrome waste, overflow & bowl grid (boxed)

Min Base Unit	450mm
Depths/Capacity	Main Bowl 194 / 27L

Finish available	
Polished	EHS1XXHOMESK
Undermounted >	

Included Accessories

Main bowl Grid - Stainless Steel

Optional Accessories

Mahogany Chopping Board CB0124

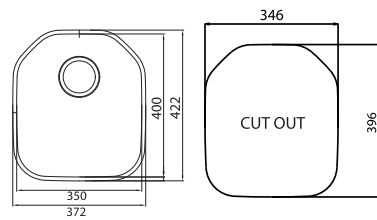

Undermount template supplied with sink

Echo S2 1.0 Bowl

C/W chrome waste, overflow & bowl grid (boxed)

Min Base Unit	600mm
Depths/Capacity	Main Bowl 194 / 40L

Finish available	
Polished	EHS2XXHOMESK
Undermounted >	

Included Accessories

Main bowl Grid - Stainless Steel

Optional Accessories

Mahogany Chopping Board CB0124

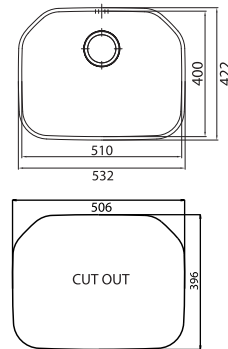

Echo D1 1.5 Bowl

C/W chrome waste, overflow, bowl grid & pipe work (boxed)

Min Base Unit	600mm
Depths/Capacity	Main Bowl 194 / 27L
	Half Bowl 115 / 6L

Finish available	
Polished LHD	EHD1XXHOMESKL
Polished RHD	EHD1XXHOMESKR
Undermounted >	

Left or Right Handed variants

Included Accessories

Main bowl Grid - Stainless Steel

Optional Accessories

Mahogany Chopping Board CB0124

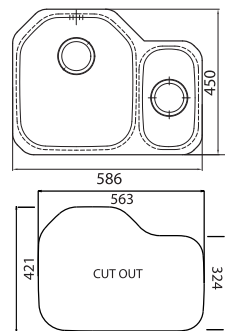

Echo D2 2.0 Bowl

C/W chrome waste, overflow, bowl grid & pipe work (boxed)

Min Base Unit	800mm
Depths/Capacity	Main Bowls 194 / 27L

Finish available	
Polished	EHD2XXHOMESK
Undermounted >	

Included Accessories

Main bowl Grids - Stainless Steel

Optional Accessories

Mahogany Chopping Board CB0124

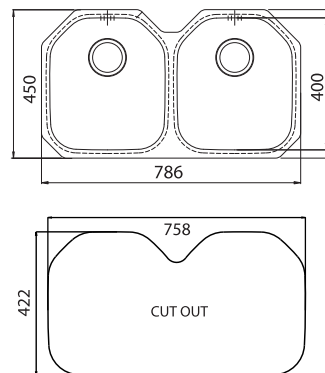

Undermount template supplied with sink

Onyx Half Bowl 4016

C/W chrome waste & demi-drainer (boxed)

Min Base Unit	Any
Depths/Capacity	Half Bowl 110 / 7L

Finish available	
Brushed	OXH2XBHOMEPK
Inset/Undermounted >	



Undermount template supplied with sink

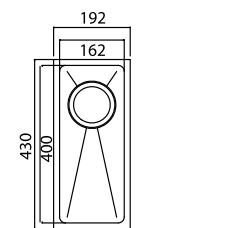

INSET CUTOUT 172 x 410mm

U/M CUTOUT 158 x 396mm
Corner radiuses 13mm

Onyx 1.0 Medium Bowl 4034

C/W chrome waste, overflow & bowl grid (boxed)

Min Base Unit	Inset 400mm
	U/M 450mm
Depths/Capacity	Main Bowl 225 / 31L

Finish available	
Brushed	OXL1XBHOMEPK
Inset/Undermounted >	

Optional Accessories

Chopping Board 51 - Mahogany NEXCB92

Undermount template supplied with sink

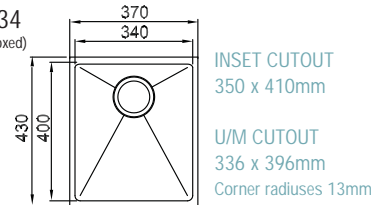

INSET CUTOUT
350 x 410mm

U/M CUTOUT
336 x 396mm
Corner radiuses 13mm



Onyx 1.0 Drainer

Drainer only c/w chrome waste (boxed)

Min Base Unit	Inset 400mm
	U/M 450mm
Depths/Capacity	Drainer 25 / 3L

Finish available	
Brushed	OXD1XBHOMESK
Inset/Undermounted >	

Optional Accessories

Chopping Board 51 - Mahogany NEXCB92

Undermount template supplied with sink

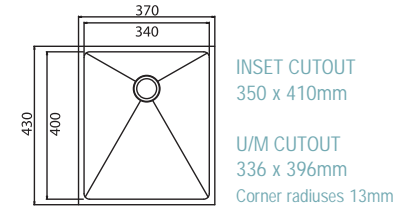

INSET CUTOUT
350 x 410mm

U/M CUTOUT
336 x 396mm
Corner radiuses 13mm



Onyx 1.0 Large Bowl 4054

C/W chrome waste, overflow & bowl grid (boxed)

Min Base Unit	Inset 600mm
	U/M 800mm
Depths/Capacity	Main Bowl 225 / 31L

Finish available	
Brushed	OXS1XBHOMEPK
Inset/Undermounted >	

Optional Accessories

Chopping Board 51 - Mahogany NEXCB92

Undermount template supplied with sink

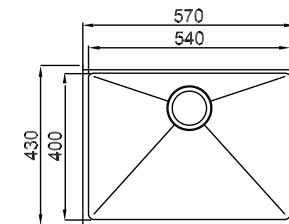

INSET CUTOUT 550 x 410mm

U/M CUTOUT 536 x 396mm
Corner radiuses 13mm

Onyx 1.0 Round Bowl 45R1

C/W chrome waste, overflow – 450 Dia (boxed)

Min Base Unit	500mm
Depths/Capacity	Main Bowl 150 / 19.8L
	Dia 450mm

Finish available	
Polished	IX0450RBHOMEPK
Inset >	

Optional Accessories

Round Chopping Board 34 - Beech CB0086HOME

Undermount template supplied with sink

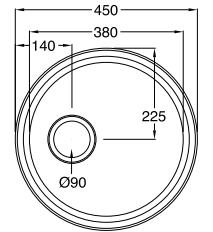

CUTOUT Dia 430mm

Onyx 1.0 Round Drainer 45R2

C/W chrome waste – 450 Dia

Min Base Unit	500mm
Depths/Capacity	Drainer 34 / 1.5L
	Dia 450mm

Finish available	
Polished	IX0450RDHOMESK
Inset >	

Optional Accessories

Round Chopping Board 34 - Beech CB0086HOME

Undermount template supplied with sink

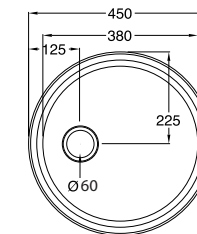

CUTOUT Dia 430mm

Onyx 1.5 Bowl

C/W chrome wastes, pipework, overflow, bowl grid & demi drainer (boxed)

Min Base Unit	600mm
Depths/Capacity	Main Bowl 225 / 31L
	Half Bowl 110 / 7L

Finish available	
Brushed (RHD only)	OX15XBHOMEPKR
Inset or Undermounted >	

Optional Accessories

Chopping Board 51 - Mahogany NEXCB92

Undermount template supplied with sink

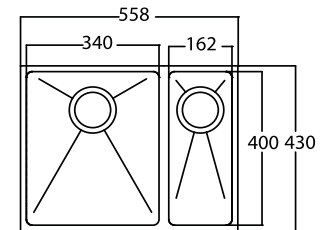

INSET CUTOUT 536 x 410mm

U/M CUTOUT 523 x 396mm
Corner radiuses 13mm



Onyx 2.0 Bowl

C/W chrome wastes, pipework, bowl grids (boxed)

Min Base Unit	800mm
Depths/Capacity	Main Bowls 225 / 31L

Finish available	
Brushed (RHD only)	OX20XBHOMEPK
Inset or Undermounted >	

Optional Accessories

Chopping Board 51 - Mahogany NEXCB92

Undermount template supplied with sink

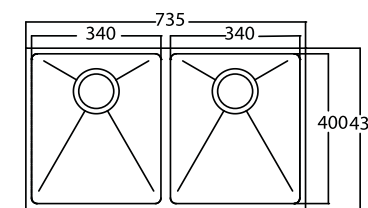

INSET CUTOUT 715 x 410mm

U/M CUTOUT 701 x 396mm
Corner radiuses 13mm



Undermounts/Inset – Steel

Please consult manufacturer for cutout sizes, or you can download templates from our website www.astracast.co.uk

Opal H1 0.5 Bowl

C/W chrome waste (boxed)

Min Base Unit 500mm
Depths/Capacity Half Bowl 120 / 6L

Finish available
Polished OPH1XXHOMESK
Undermounted >

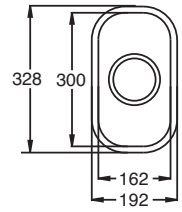

CUTOUT 162 x 300mm
Corner radiuses 60mm

Undermount template supplied with sink

Opal S1 Large Bowl

C/W chrome waste & overflow (boxed)

Min Base Unit 500mm (in longest orientation)
Depths/Capacity Main Bowl 170 / 23.6L

Finish available
Polished OPS1XXHOMESK
Undermounted >

Optional Accessories

Basket - Stainless Steel BK0538XXHOME
Wooden Chopping Board 03 - Beech CB0060XXHOME
Nylon Chopping Board 04 - White CB0071XXHOME

Undermount template supplied with sink

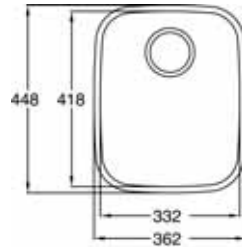

CUTOUT 332 x 418mm
Corner radiuses 70mm

Opal S2 Classic Bowl

C/W chrome waste & overflow

Min Base Unit 600mm
Depths/Capacity Main Bowl 187 / 29.5L

Finish available
Polished OPS2XXHOMESK
Undermounted >

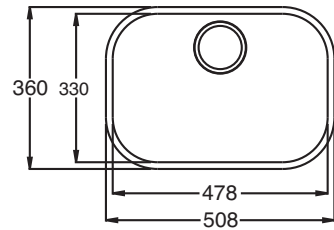

CUTOUT 478 x 330mm
Corner radiuses 100mm

Undermount template supplied with sink

Opal S3 1.5 Bowl

C/W chrome wastes, overflow & pipe work (boxed)

Min Base Unit 600mm
Depths/Capacity Main Bowl 175 / 24L
Half Bowl 115 / 6L

Finish available
Polished LHD OPS3XXHOMESKL1
Polished RHD OPS3XXHOMESKR1
Undermounted > Left or Right Handed

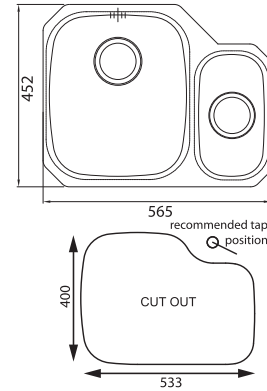

Undermount template supplied with sink

Opal R1 Round Bowl

C/W chrome waste & overflow (boxed)

Min Base Unit 500mm
Depths/Capacity Main Bowl 170 / 19L

Finish available
Polished OPR1XXHOMESK
Undermounted >

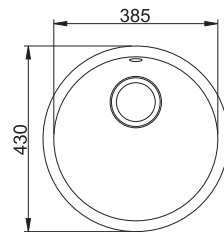

CUTOUT Dia 381mm

Undermount template supplied with sink

Opal R2 Round Drainer

C/W chrome waste (boxed)

Min Base Unit 500mm
Depths/Capacity Main Bowl 35 / 1.6L

Finish available
Polished OPR2XXHOMESK
Undermounted >

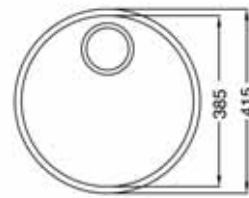

CUTOUT Dia 381mm

Undermount template supplied with sink

Opal 0.5 Bowl

C/W chrome waste (boxed)

Min Base Unit Any
Depths/Capacity Half Bowl 115 / 5.5L

Finish available
Polished OPO5XXHOMESK
Undermounted >

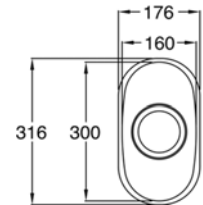

Undermount template supplied with sink

Opal 1.0 Bowl

C/W chrome waste (boxed)

Min Base Unit 500mm
Depths/Capacity Main Bowl 152 / 20.7L

Finish available
Polished OP10XXHOMESK
Undermounted >

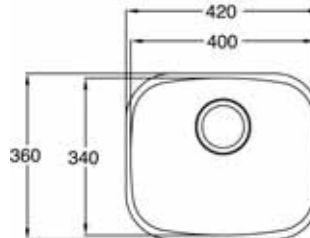

Undermount template supplied with sink

Opal 1.5 Bowl

C/W chrome wastes & pipe work (boxed)

Min Base Unit 600mm
Depths/Capacity Main Bowl 148 / 20L
Half Bowl 109 / 5L

Finish available
Polished OP15XXHOMESK
Undermounted > Reversible

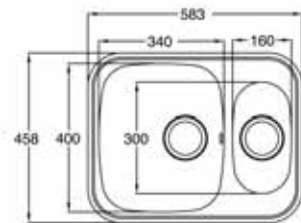

CUTOUT 563 x 438mm
Corner radiuses 82mm

Undermount template supplied with sink



Undermounts – Ceramic

Please note: *Due to material properties and the handmade manufacturing process dimensions may vary from guidelines below. We strongly recommend any cut outs to worktops are made based on your individual sink dimensions.

Lincoln 2035 Half Bowl

C/W chrome waste (boxed)

Min Base Unit 400mm
Depths/Capacity Half Bowl 115 / 8L

Colour available
Gloss White LNH1WHHOMESK
Undermounted >

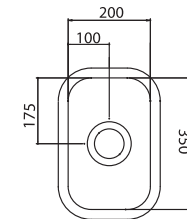

CUTOUT 195 x 345mm
Corner radiuses 68mm

Undermount template supplied with sink

Lincoln 2540 Half Bowl

C/W chrome waste & overflow (boxed)

Min Base Unit 400mm
Depths/Capacity Half Bowl 160 / 16L

Colour available
Gloss White LNH2WHHOMESK
Undermounted >

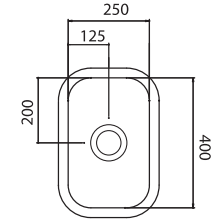

CUTOUT 245 x 395mm
Corner radiuses 68mm

Undermount template supplied with sink

Lincoln 3040 Main Bowl

C/W chrome waste & overflow (boxed)

Min Base Unit 400mm
Depths/Capacity Main Bowl 160 / 19L

Colour available
Gloss White LNS1WHHOMESK
Undermounted >

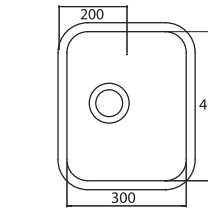

CUTOUT 295 x 395mm
Corner radiuses 68mm

Undermount template supplied with sink

Lincoln 4040 Main Bowl

C/W chrome waste & overflow (boxed)

Min Base Unit 500mm
Depths/Capacity Main Bowl 180 / 27L

Colour available
Gloss White LNS2WHHOMESK
Undermounted >

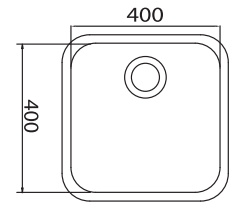

CUTOUT 395 x 395mm
Corner radiuses 68mm

Undermount template supplied with sink

Lincoln 5040 Main Bowl

C/W chrome waste & overflow (boxed)

Min Base Unit 600mm
Depths/Capacity Main Bowl 180 / 36L

Colour available
Gloss White LNS3WHHOMESK
Undermounted >

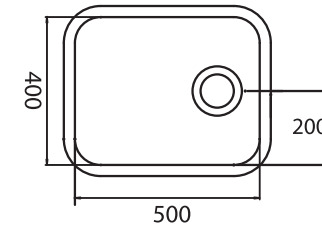

CUTOUT 495 x 395mm
Corner radiuses 68mm

Undermount template supplied with sink

Lincoln R1 Round Bowl

C/W chrome waste & overflow (boxed)

Min Base Unit 500mm
Depths/Capacity Main Bowl 180 / 23L
Dia 400mm x 180mm

Colour available
Gloss White LNR1WHHOMESK
Undermounted >

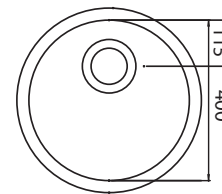

CUTOUT dia 395mm

Undermount template supplied with sink

Lincoln R2 Round Drainer

C/W chrome waste (boxed)

Min Base Unit 500mm
Depths/Capacity Main Bowl 35 / 4.5L
Dia 400mm x 35mm

Colour available
Gloss White LNR2WHHOMESK
Undermounted >

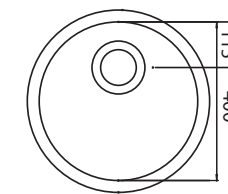

CUTOUT dia 395mm

Undermount template supplied with sink

Lincoln 1.5 Bowl

C/W chrome waste & pipework (boxed)

Min Base Unit 600mm
Depths/Capacity Main Bowl 180 / 23.5L
Half Bowl 116 / 5L

Colour available
Gloss White RHD LNR1WHHOMESK
Undermounted >

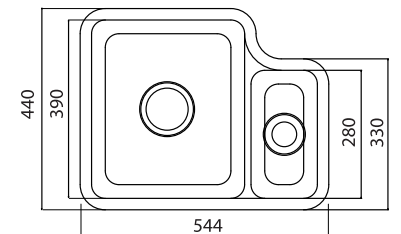

Undermount template supplied with sink

Vero 0.5 Bowl

C/W chrome waste & overflow (boxed)

Min Base Unit 400mm
Depths/Capacity Half Bowl 130 / 5L

Colours available
Matt White VO05WHNEXSK
Black Granite VO05GBNEXSK
Undermounted >

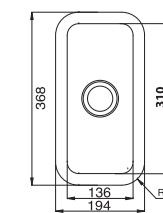

CUTOUT 142 x 316mm
Corner radiuses 27mm

Undermount template supplied with sink

Vero Medium Bowl

C/W chrome waste & overflow (boxed)

Min Base Unit 500mm
Depths/Capacity Main Bowl 200 / 30L

Colours available
Matt White VO10WHNEXSK
Black Granite VO10GBNEXSK
Undermounted >

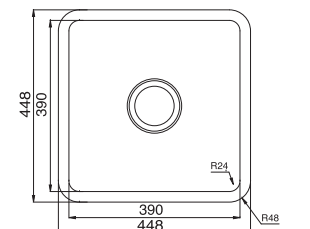

Undermount template supplied with sink

CUTOUT 396 x 396mm
Corner radiuses 27mm

Vero Large Bowl

C/W chrome waste & overflow (boxed)

Min Base Unit 600mm
Depths/Capacity Main Bowl 200 / 38L

Colours available
Matt White VO10WHNEXSK
Black Granite VO10GBNEXSK
Undermounted >

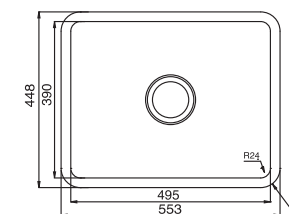

CUTOUT 501 x 396mm
Corner radiuses 27mm

Undermount template supplied with sink

Vero 1.5 Bowl

C/W chrome wastes & pipe work (boxed)

Min Base Unit 800mm
Depths/Capacity Main Bowl 185 / 26L
Half Bowl 120 / 6L

Colour available
Matt White VO15WHNEXSK
Black Granite VO15GBNEXSK
Undermounted >

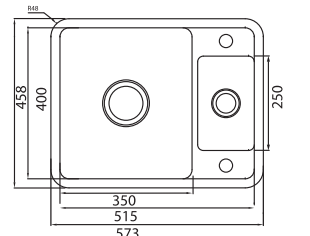

Undermount template supplied with sink

CUTOUT 521 x 406mm
Corner radiuses 27mm

Sink Minimum Base Unit Matrix

Stainless Steel	Any	400	450	500	600	800	900	1000	Bespoke
Profile 1.0 Bowl					✓				
Profile 1.5 Bowl					✓				
Vantage 1.0 Bowl					✓				
Vantage 1.5 Bowl					✓				
Bistro 1.0 Bowl								✓	
Bistro 1.5 Bowl								✓	
Olympus 1.0 Bowl						✓			
Belfast 1.0 Bowl									✓
Lausanne 1.0 Bowl				✓					
Lausanne 1.5 Bowl					✓				
Echo 1.0 Bowl					✓				
Echo 1.5 Bowl					✓				
Korona 1.0 Bowl					✓				
Korona 1.5 Bowl					✓				
Montreux 1.0 Bowl				✓					
Montreux 1.5 Bowl					✓				
Topaz 1.0 Bowl				✓					
Topaz 1.5 Bowl					✓				
Alto 1.0 Bowl				✓					
Alto 1.5 Bowl					✓				
Orb Round Bowl		✓							

Composite	Any	400	450	500	600	800	900	1000	Bespoke
Ellipse 1.0 Bowl					✓				
Geo 1.0 Bowl					✓				
Geo 1.5 Bowl					✓				
Helix 1.0 Bowl					✓				
Helix 1.5 Bowl					✓				
Lausanne 1.0 Bowl				✓					
Lausanne 1.5 Bowl					✓				
Vector 1.5 Bowl						S R	C U		
Korona 1.0 Bowl					✓				
Korona 1.5 Bowl					✓				
Korona 2.0 Bowl						✓			
Cascade 1.0 Bowl			✓						
Vortex Round Bowl				IN	U/IN				
Vortex Round Drainer				IN	U/IN				

Ceramic	Any	400	450	500	600	800	900	1000	Bespoke
Essenza 1.5 Bowl					✓				
Onesto 1.5 Bowl					✓				
Geo 1.0 Bowl					✓				
Geo 1.5 Bowl					✓				
Jersey 1.5 Bowl								✓	
Equinox 1.0 Bowl					✓				
Equinox 1.5 Bowl					✓				
Edinburgh 1.0 Bowl									✓
Aquitaine 1.0 Bowl				✓					
Aquitaine 1.5 Bowl					✓				
Belfast									✓
Canterbury 1.5 Bowl									✓

Ceramic	Any	400	450	500	600	800	900	1000	Bespoke
Sudbury 1.0 Bowl									✓
Sudbury 2.0 Bowl									✓

Stainless Undermount	Any	400	450	500	600	800	900	1000	Bespoke
Edge H1 0.5 Bowl	✓								
Edge S1 1.0 Bowl			✓						
Edge S2 1.0 Bowl					✓				
Edge D1 1.5 Bowl					✓				
Echo H1 0.5 Bowl	✓								
Echo S1 1.0 Bowl			✓						
Echo S2 1.0 Bowl					✓				
Echo D1 1.5 Bowl					✓				
Echo D2 2.0 Bowl						✓			
Onyx 4016 Half Bowl	✓								
Onyx 4034 1.0 Bowl		IN	UN						
Onyx 4034 Drainer		IN	UN						
Onyx 4054 1.0 Bowl					IN	UN			
Onyx 4053 1.5 Bowl					✓				
Onyx 4070 2.0 Bowl						✓			
Onyx 45R1 Round Bowl					✓				
Onyx 45R2 Round Bowl					✓				
Opal H1 0.5 Bowl					✓				
Opal S1 Large Bowl					✓				
Opal S2 Classic Bowl						✓			
Opal S3 1.5 Bowl						✓			
Opal R1 Round Bowl					✓				
Opal R2 Round Drainer					✓				
Opal 0.5 Bowl	✓								
Opal 1.0 Bowl					✓				
Opal 1.5 Bowl						✓			

Ceramic Undermount	Any	400	450	500	600	800	900	1000	Bespoke
Lincoln 2035 Half Bowl		✓							
Lincoln 2540 Half Bowl		✓							
Lincoln 3040 Main Bowl		✓							
Lincoln 4040 Main Bowl				✓					
Lincoln 5040 Main Bowl					✓				
Lincoln R1 Round Bowl				✓					
Lincoln R2 Round Drainer				✓					
Lincoln 1.5 Bowl					✓				
Vero Half Bowl		✓							
Vero Medium Bowl				✓					
Vero Large Bowl				✓					
Vero 1.5 Bowl						✓			

S R: Straight Run
 C U: Corner Unit
 IN: Inset
 U/IN: Undermount/Inset Together
 UN: Undermount



ASTR▲CAST®
INNOVATION • DESIGN • PERFORMANCE

Woodlands | Roydsdale Way | Euroway Trading Estate
Bradford | West Yorkshire | BD4 6SE

SALES ENQUIRIES

Tel: 01274 475 179 Fax: 01274 654 176
Email: sales@astracast.co.uk

AFTER SALES ENQUIRIES

Tel: 01274 475 160 Fax: 01274 654 771
Email: aftersales@astracast.co.uk